

1933-34 Pickup & Truck Radiator Shell, Hood, Fenders and running boards

Front Splash Apron

Fiberglass



FSA3334PU 120.00 ea

Hood Side Panel Options

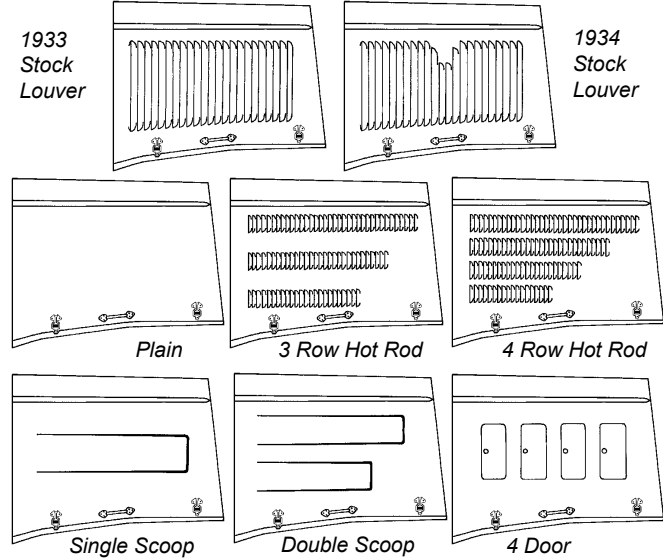

1933 Stock Louver

1934 Stock Louver

Plain

3 Row Hot Rod

4 Row Hot Rod

Single Scoop

Double Scoop

4 Door

1933 Radiator Cap and Ford Emblems

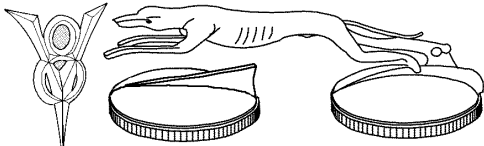

B-8212	Ford Emblem, chrome w/blue background	37.50	ea
40-8217-A	V8 Emblem, chrome	22.50	ea
46-8100-A	Radiator Cap, chrome	20.00	ea
B-8100-G	Greyhound radiator cap, (1932, works on PU)	90.00	ea

1934 Grille Ornament & Radiator Cap

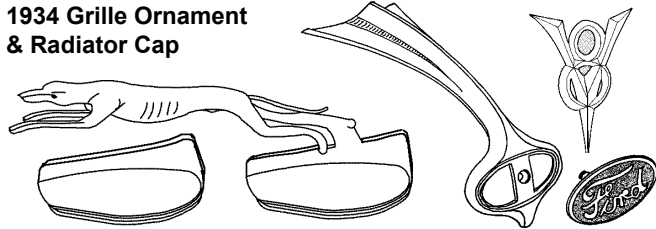

46-8215	Grille ornament	32.50	ea
B-8212	Ford emblem	37.50	ea
40-8217-A	V8 Emblem, chrome	22.50	ea
46-8100	Radiator Cap (stock)	20.00	ea
46-8100-AG	Greyhound Radiator Cap	90.00	ea

Grille

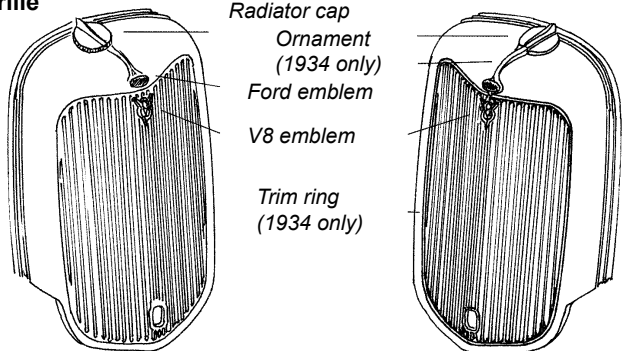

46-8200-A	1933 Grille	n.a	
46-8200-B	1934 Grille	n.a	
46-8234	1934 Trim ring	n.a	
68-20004	Grille trim clip set	7.50	set
46-8094-BS	Grille to radiator spacers and bolts	40.00	ea
A-8201-BM	Grille to spacer bracket bolts only	2.00	set

1933-34 Pickup & Panel Hoods

Stamped steel hoods by Rootlieb.

4 piece hood tops use the V8 passenger style hood center hinge strip (included with hood top panels). Hood handles, latch clips, and side hinge rods are included with 4 pc side panels. 3 piece hoods have lips on the top and sides that fold inwards. Exterior handles and mounting hardware are not included.

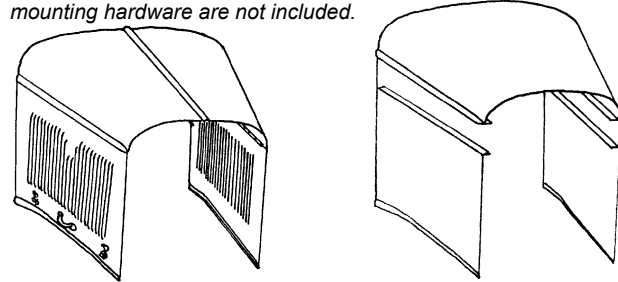

4 Piece		3 Piece (1 pc top)	
Top, Plain	46-16710-2 300.00 ea	46-16710-3	300.00 ea
Top, Louvered, (6 rows)	46-16710-2L6 300.00 ea	46-16710-3L6	n.a
Sides, 1933 Stock style	46-16712-A 250.00 pr	46-16713-A	225.00 pr
Sides, 1934 Stock style	46-16712-B 300.00 pr	46-16713-B	225.00 pr
Sides, Hot rod (3 row)	46-16712-H 300.00 pr	46-16713-H	225.00 pr
Sides, Hot rod (4 row)	46-16712-H4 300.00 pr		
Sides, Plain	46-16712-P 300.00 pr	46-16713-P	225.00 pr
Sides, 4 door	46-16712-D 675.00 pr		
Sides, Single scoop	46-16712-S1 525.00 pr	46-16713-S1	475.00 pr
Sides, Double scoop	46-16712-S2 800.00 pr	46-16713-S2	725.00 pr

1933-34 Pickup & Truck Radiator Shell, Hood, Fenders and running boards

Hood Hinge Brackets

Original type: Stainless, use with original interlocking center hood hinge.

46-8220	Front	22.50	ea
46-8221	Rear	22.50	ea

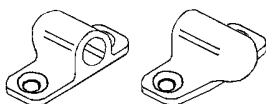

Hood V8 Center Hinge Brackets

Use with Rootlieb Hood w/V8 hinge

Front or Rear:

Chrome plated

B-8220	10.00	ea
--------	-------	----

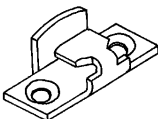

1928-36 Accessory Hood Supports, Stainless Steel

HR-16780-SS	Mount to radiator support rods	25.00	ea
-------------	--------------------------------	-------	----

Hood Latches (original type)

Hood Latches

B-16750	Plain	22.50	ea
B-16750-SS	Stainless	17.50	ea

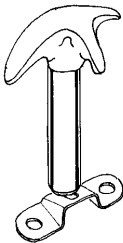

Hood Latch Mount Screw Set

B-16750-MS	Stainless Steel	5.00	set
------------	-----------------	------	-----

Hood Latch to Fender Pads, Rubber

B-16750-PAD	oblong type	17.50	ea
B-35630	oval type	5.00	pr

Hood Side Hardware and Bumpers

A-16636	Hood side handles, Plain, w/rivets	25.00	pr
A-16636-SS	Hood side handles, Stainless, w/screws	30.00	pr
B-16751-S	Hood latch catch brackets, set of 4 w/rubbers	30.00	set
B-16751-SS	Hood latch catch set, stainless	30.00	set
A-16751-RS	Dummy (threaded) rivets, chrome, set of 20	5.00	set
B-16761	Hood bumper set	22.50	set
B-16718-S	Center bumper bracket (mounts to fender)	22.50	pr

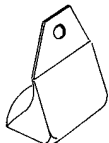

Hidden Hinges and Braces for 3-Piece Hoods

Hidden hinge and latch kit by DF Metalworks includes hinges, latches, and side panel lower alignment pins. All special hardware and detailed instructions are included.

Brace kit prevents hood flexing and helps prevent paint cracking

Hinge Kit:

B-16711-DF	LH Open	300.00	set
B-16711-DF2	2 Way	375.00	set

Brace Kit:

46-16714-DF	1930-31	80.00	set
-------------	---------	-------	-----

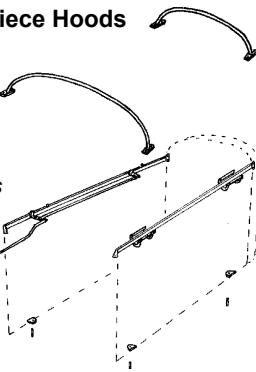

Hood Lacing

50-16739-S	Grille, fabric w/rivets	10.00	ea
48-16740-S	Cowl, fabric w/screws	12.50	ea
HR-16739	Foam rubber, 3/8" x 3/16" (most rad shells)	10.00	ea
HR-16740	Foam rubber, 5/8" x 3/8" (most cowls)	12.50	ea

1934 Pickup

Hood Side Emblems

46-16606	"Ford"	105.00	ea
46-16607	"V8"	17.50	ea

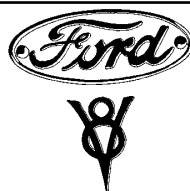

Fenders, Fiberglass

Front fenders fit 1933-34 Pickup, Panel, and Trucks.

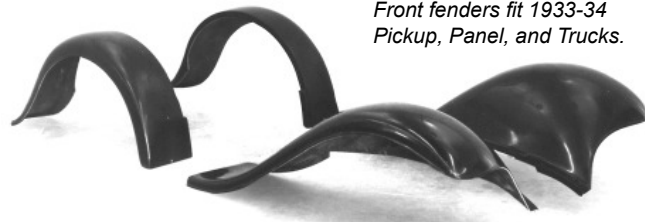

RFF3334PU	RH Front, plain	365.00	ea
LFF3334PU	LH Front, plain	365.00	ea
RFF3334PU6	RH Front w/6" spare tire well	455.00	ea
LFF3334PU6	LH Front w/6" spare tire well	455.00	ea
RFF3334PU8	RH Front w/8" spare tire well	455.00	ea
LFF3334PU8	LH Front w/8" spare tire well	455.00	ea
RRF3334PU	RH Rear: Pickup & Panel	260.00	ea
LRF3334PU	LH Rear: Pickup & Panel	260.00	ea

Pickup rear fenders can be converted to Panel rear fenders by trimming inside mounting flanges to match the panel body.

Front Fender Bracket and Bolts

Fender Bracket

46-16025-R	RH	n.a
46-16025-L	LH	n.a

Front fender to fender bracket:

B-16026-S2	1/2" long	2.00	pr
------------	-----------	------	----

Front fender to frame (slotted)

A-16027-SS	Set of 4	2.50	set
------------	----------	------	-----

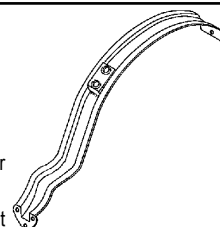

Rear Wheelwell Studs

Large head fender mount bolt, spot welds to wheelwell of pickup box.

AH-1173	Set of 4	2.50	set
---------	----------	------	-----

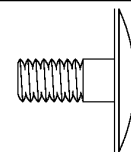

Fender Welt

Black vinyl, 25 ft. length

48-16070-B	3/16" bead	10.00	ea
48-16070-D	1/4" bead	10.00	ea

Vinyl, clad w/stainless bead, 8 ft. length

48-16070-SS	7/32" bead	20.00	ea
-------------	------------	-------	----

Vinyl, COLORED, Use part suffix to indicate color

Maroon: -MR, Caramel: -CR, Medium Blue: -BLM, Red: -RD, Dark Brown: -BRD, Dark Green: -GRD, White: -WH, Grey: -GY, Bright Orange: -OR, Yellow: -YL, Bright Red: -RR			
48-16070-xx	25 ft length, Specify Color	35.00	ea

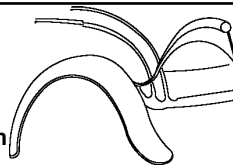

Running Boards, fit all 1/2 ton

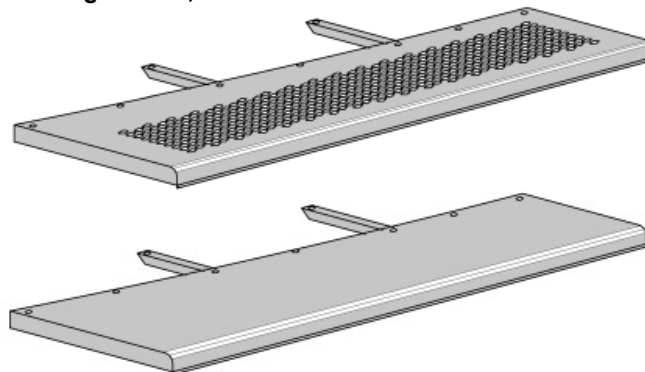

46-16450-S	Stamped steel, w/stock diamond tread	375.00	pr
46-16450-SM	Stamped steel, smooth	300.00	pr