

Grille Ornament

Ornament, Chromed
48-8215 80.00 ea

Ford Emblem
Chrome with blue background
40-8212-B 15.00 ea

Accessory Greyhound
Chrome, Mounts to ornament
48-8100-G 90.00 ea

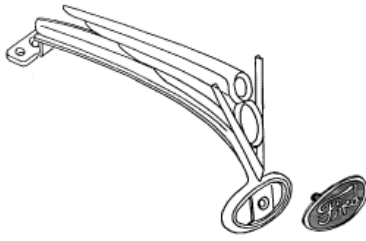

1935 Passenger Grille

Grille:
48-8200 n.a

Grille trim set with mount clips:
Stainless Steel
48-8234 110.00 ea

Grille trim mount clip set (34 pcs):
48-20001 10.00 set

Grille Bug Screen
48-18700 37.50 ea

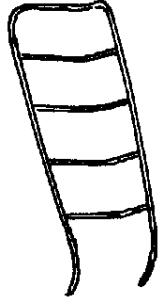

Grille Inner Baffle

Fiberglass

GSP35P 140.00 ea



1935 Passenger Hoods

Stamped steel hoods by Rootlieb. 4 piece hood tops include center hinge strip. Latch handles, springs, and side hinge rods are included with 4 piece side panels. Three piece hoods have lip that on top and sides that fold inwards, no hardware included. Top can be used as one piece top.

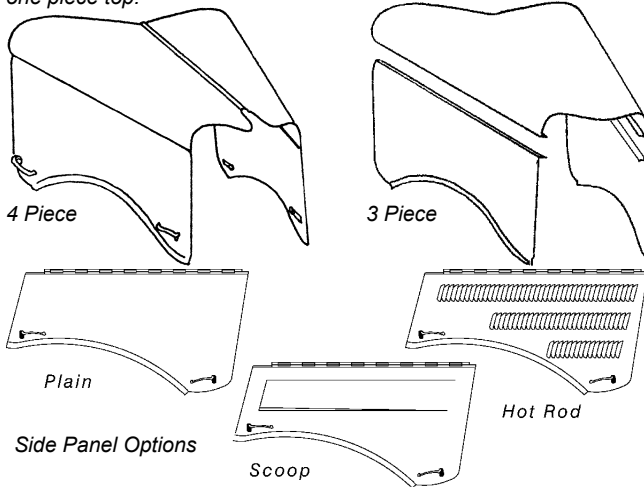

	4 Piece		3 Piece	
Top, Smooth	48-16710	350350.00ea	48-16710-3	425.00 ea
Top, 6 rows louvers	48-16710-L	450450.00ea	48-16710-3L	575.00 ea
Sides, Hot rod	48-16712-H	375375.00pr	48-16713-H	275.00 pr
Sides, Plain	48-16712-P	325325.00pr	48-16713-P	275.00 pr
Sides, Scoop	48-16712-S	625625.00pr	48-16713-S	500.00 pr

Hood Lacing on Grille or Cowl

We recommend fabric or hard rubber lacing for 4 piece hoods, foam rubber should only be used with 3 piece hoods.

40-16739-S	Grille: 1933-35 Pass, fabric w/rivets	10.00 ea
48-16740-S	Cowl: 1935 Passenger, fabric, w/screws	12.50 ea
HR-16739	Foam rubber, 3/8" x 3/16" (most rad shells)	10.00 ea
HR-16740	Foam rubber, 5/8" x 3/8" (most cowls)	12.50 ea

1935 Passenger



Grille, Hood, Fenders, and Running Boards

Hidden Hinges and Braces for 3-Piece Hoods

Hidden hinge and latch kit by DF Metalworks includes hinges, latches, and side panel lower alignment pins. All special hardware and detailed instructions are included.

Brace kit prevents hood flexing and helps prevent paint cracking

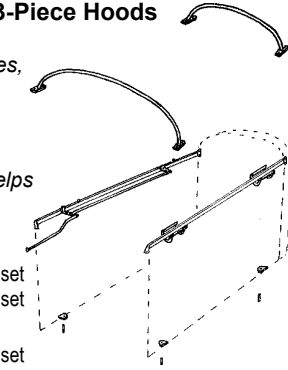

Hinge Kit:

A-16711-DF	LH Open	300.00 set
A-16711-DF2	2 Way	375.00 set

Brace Kit:

A-16714-BDF	1930-31	80.00 set
-------------	---------	-----------

4 Piece Hood Hinge

Hinge Brackets (front or rear)		
B-8220	stainless	10.00 ea

Center hinge strip		
40-16632	stainless, 33" long	17.50 ea

Side Panel Hinge Rods		
48-16631-S	stainless, 37 3/4"	20.00 pr

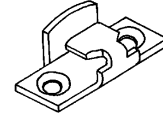

1928-36 Accessory Hood Supports, Stainless Steel

HR-16780-SS	Mount to radiator support rods	25.00 ea
-------------	--------------------------------	----------

Hood Side Trim & Hardware

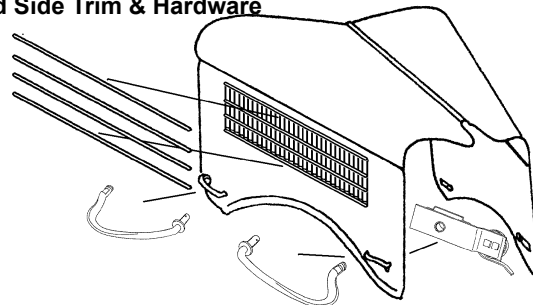

40-16636-BR	Handle, RH front, LH rear, bronze	12.50 ea
40-16636-BL	Handle, LH front, RH rear, bronze	12.50 ea
48-16644/5-B	Handles, set of 4, polished stainless	150.00 set
40-16637-BR	Bracket & Spring, RH front, LH rear	20.00 ea
40-16637-BL	Bracket & Spring, LH front, RH rear	20.00 ea
48-16722	Side trim, stainless, set of 8 with clips	105.00 set
48-20004	Side trim clip set (32 pcs)	10.00 set

Hood Rubber Bumper Sets

48-16761	1935 Passenger (w/corner rubber)	22.50 set
----------	----------------------------------	-----------

1935 Passenger Grille, Hood, Fenders and running boards

1935 Passenger Front Fenders, Fiberglass



RFF35P	RH Front fender	470.00	ea
LFF35P	LH Front fender	470.00	ea
RFI35P	RH inner fender	130.00	ea
LFJ35P	LH inner fender	130.00	ea

Front Fender Brackets

Headlight Support

Fender/headlight support:

48-16025-R	RH:	n.a	
48-16025-L	LH:	n.a	
Support bracket to frame strut:			
48-16067-R	RH:	10.00	ea
48-16067-L	LH:	10.00	ea

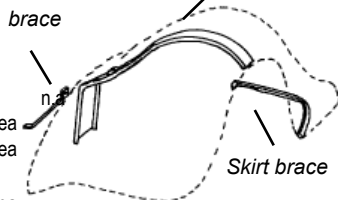

Skirt brace, RH or LH

48-16094		17.50	ea
----------	--	-------	----

Rear Fender brace

48-16391	RH or LH	17.50	ea
----------	----------	-------	----



1935-36 Fender Stone Guard Brace Set

Set of four stone guard/fender braces. Mfg by Bitchin Products, these replace the fender braces behind each wheel.

BN-351043	1935-36 Set of 4	200.00	ea
-----------	------------------	--------	----

1935-36 Fender Washer Sets

Set of 28 washers, enough for both front and rear fenders.

48-16008-SK		7.50	ea
-------------	--	------	----



5/16-24 Cage Nuts

Welded to body and frame for fender and running board mounting.

AH-3145	Cage nut	1.00	ea
---------	----------	------	----

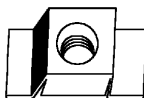

1935 Coupe, Roadster, & Cabriolet Rear Fenders

Fiberglass

Right:			
RRF35CR		380.00	ea

Left:			
LRF35CR		380.00	ea



1935 Sedan & Phaeton Rear Fenders

Fiberglass

Right:			
RRF35SPH		380.00	ea

Left:			
LRF35SPH		380.00	ea



1935-36 Station Wagon & Sedan Delivery Rear Fenders

Fiberglass

Note: Inner flange of fender needs to be trimmed to fit Sedan Delivery

Right:			
RRF3539SD		380.00	ea

Left:			
LRF3539SD		380.00	ea



Fender Welt

Black vinyl, 25 ft. length

48-16070-B	3/16" bead	10.00	ea
48-16070-D	1/4" bead	10.00	ea

Vinyl, clad w/stainless bead, 8 ft.

48-16070-SS	7/32" bead	20.00	ea
-------------	------------	-------	----

Vinyl, COLORED, Use part suffix to indicate color

Maroon: -MR, Caramel: -CR, Medium Blue: -BLM, Red: -RD, Dark Brown: -BRD, Dark Green: -GRD, White: -WH, Grey: -GY, Bright Orange: -OR, Yellow: -YL, Bright Red: -RR
48-16070-xx 25 ft length, Specify Color 35.00 ea

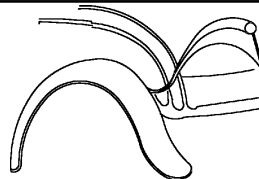

1935-36 Passenger Running Boards

Fiberglass, smoothie style

Fiberglass boards are very strong, over 1/4" thick. They have the proper arch for excellent fit and appearance



LRB3536PS	RH, smooth running board	345.00	ea
LRB3536PS	LH, smooth running board	345.00	ea

Steel boards and rubber covers:

Steel boards with vulcanized rubber covers are excellent quality.

48-16450/1-BD	Steel boards w/molded rubber cover	1400.00	ea
48-16450/1	Molded rubber replacement covers	180.00	pr
48-16455-MB	1935-48 Running board mount bolt	1.00	ea

1935-36 Passenger Running Board Moldings

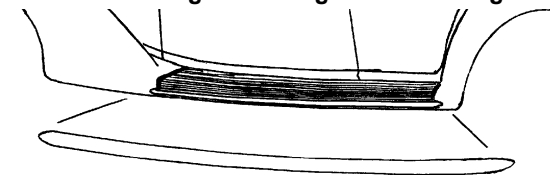

48-16462-S	Stainless moldings	95.00	pr
------------	--------------------	-------	----