

Universal Window Felt Parts

Door Window Felt Strips, Universal, 8' Strips

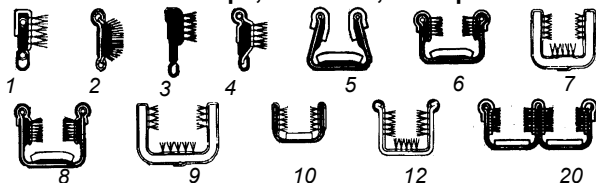

H-45983-1	Single side strip, black bead, 7/16	25.00	ea
H-45983-2	Single side strip, stainless bead, 7/16	17.50	ea
H-45983-3	Single side strip, black bead, 9/16	27.50	ea
H-45983-4	Single side strip, black, pile lined, 9/16	27.50	ea
H-45983-5	U shape, flexible, felt, black	35.00	ea
H-45983-6	U shape, flexible, felt & pile lined, black	35.00	ea
H-45983-7	U shape, flexible, pile lined, black	35.00	ea
H-45983-8	U shape, flex, felt & pile lined, stainless bead	35.00	ea
H-45983-9	U shape, flex, pile line, 7/16 to 1/2 glass	35.00	ea
H-45983-10	U shape, rigid, felt & pile lined, black	27.50	ea
H-45983-12	U shape, rigid, pile lined, stainless bead	35.00	ea
H-45983-20	Double U shape, flexible, pile & felt lined used on some station wagon sliding windows	45.00	ea

Window Glass to Frame Setting Tape

B-37193-A	All years, 20 ft, 1/32" thick	5.00	ea
B-37193-B	All years, 20 ft, 3/64" thick	7.50	ea
B-37193-C	All years, 20 ft, 1/16" thick	10.00	ea
B-37193-D	All years, 20 ft, 5/64" thick	10.00	ea

Window Felt Mounting Hardware

Sets of 25. these clips are included in complete window felt kits.

B-703536	Small headed screws, black, used to mount fuzzy strips to window openings when original hardware is not used	3.00	set
48-703536-A	Punch Clips used 1935-52	7.50	ea
48-703536-B	Garnish Clips used 1935-36	7.50	ea
78-703536	Staples used 1937-48	3.00	ea
11A-703536	V Clips used 1941-48	7.50	ea

1932-35 Window Glass Anti-Rattlers

Fits into holes in door, body, and garnish molding. Included in felt kits.

B-46044	Door or body	0.75	ea
B-45830	Garnish molding	0.50	ea

Window Glass Top Cushion Only

Note: Top cushion is included in window felt kits when needed.

A-45983-T	1928-31 (1 required per window)	2.50	ea
T-8399-T	1926-27 Tudor sedan quarter window	5.00	ea

Window Glass Bottom Rest Bumper

Included in felt kits.

B-48141	1926-34	0.75	ea
---------	---------	------	----

Power Window Regulators

"Geared" Power Window Kits by Specialty Power Windows

This kit features AC Delco motors and includes regulators, window glass bottom channels, necessary mounting brackets, control switches, and switch wire harnesses. Minimum 24" glass width.

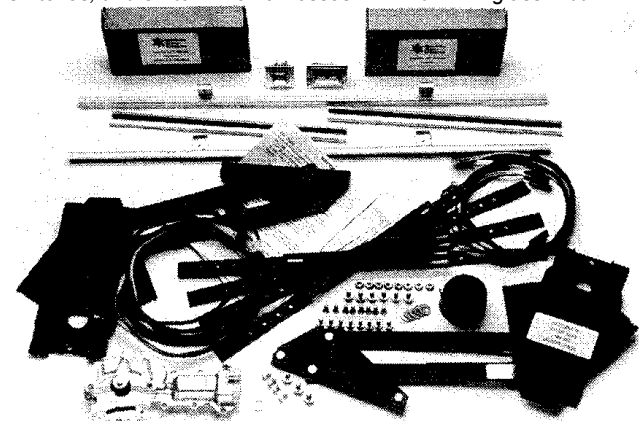

SPW-48100-A	2-Window, for Coupe, Convrt*, Pickup	450.00	set
SPW-48100-C	4-Window, for Sedan	825.00	set

*Convertibles may need fabrication of upper stops for proper glass top control.

Geared Regulator Kit for Model A

Specially designed for easy installation into 1928-31 Model A. These are single arm regulators. Kit includes wiring and switches.

SPW-48100-MA	2-Window, for Coupe & Pickup	450.00	ea
SPW-48100-MC	4-Window, for Sedan	825.00	ea

Wonder Lift Regulator Kits by Specialty Power Windows

This kit features Bosch motors and includes regulators, window glass bottom channels, necessary mounting brackets, control switches, and switch wire harnesses.

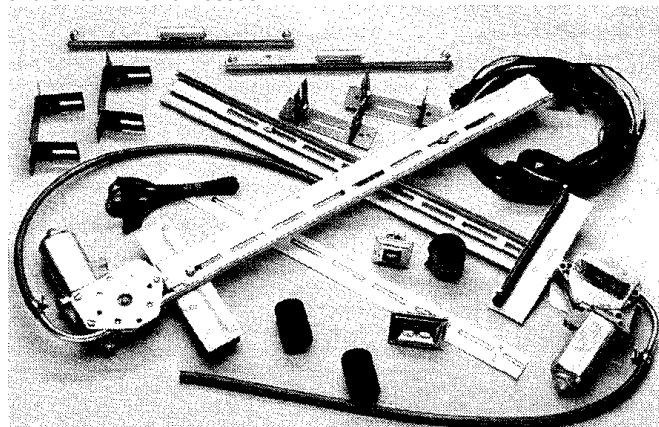

SPW-48100-LA	2-Window, for Coupe & Pickup	450.00	set
SPW-48100-LC	4-Window, for Sedan	825.00	set

Back Window Power Window Unit

We designed it for our 1932 3-Window Coupe, Specialty Power Windows makes it. Requires fabrication of a new mounting base plate to use on steel cars. Other fiberglass cars may need extra modifications to mount base plate and mount window channels.

SPW-48100-RW	Back Window Power Unit	275.00	ea
--------------	------------------------	--------	----

1926-31 Window Parts

Door Garnish Moldings,

**1926-27 Coupe & Tudor Sedan,
1928-29 Pickup**

Stamped Steel

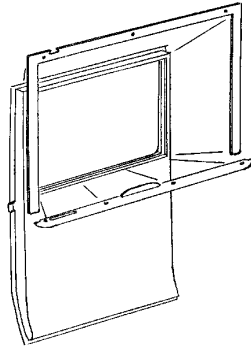

Door lower, finger pull
A-80033-S 130.00 pr

Door upper frame
1928-29 Pickup Style
A-80025 RH 95.00 ea
A-80026 LH 95.00 ea

**1926-27 Coupe
Quarter Window
Garnish Moldings**

*Fiberglass with return flange
against door edge, not a raw edge*



CG2627QR RH 165.00 ea
CG2627QL LH 165.00 ea

**1926-27 Tudor Sedan
Quarter Window
Garnish Moldings**

Upper
T-16051-UQ n.a

Lower
(1928-31: Trim to fit 1926-27)
A-56050-Q 130.00 pr

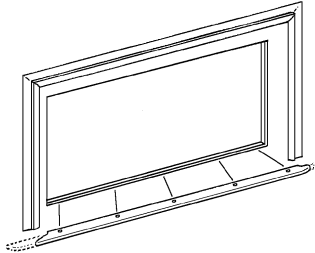

**1926-27 Coupe & Tudor Back
Window Garnish Molding**

*Fiberglass with return flange
against door edge, not a raw edge.*
RWM2627CS 150.00 ea



**Door & Door Opening Garnish Moldings
1928-31 Coupe & Tudor Sedan & 1930-31 Pickup**

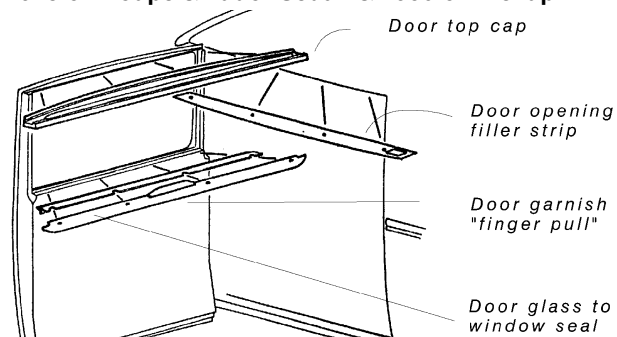

Door "finger pull" garnish moldings:
A-46050-AS 1928-29 Coupe & Tudor 130.00 pr
A-46050-DS 1930-31 Coupe 130.00 pr
A-46050-CS 1930-31 Tudor & Pickup 130.00 pr

Door top cap:
A-45883-A 1928-31 Tudor, 1928-29 Coupe, 1930-31 PU 40.00 ea
A-45883-B 1930-31 Coupe 40.00 ea

Door opening filler strips:
A-45891-AS 1928-31 Tudor, 1928-29 Coupe, 1930-31 PU 32.50 pr
A-45891-BS 1930-31 Coupe 32.50 pr

1926-31 Window Parts, cont

1928-31 Window Garnish Seals & Brackets
Mounts under garnish molding, seals against glass.

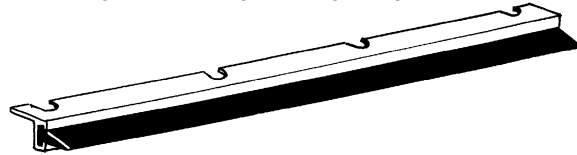

A-19008-A 1928-29 Coupe, 1930-31 Pickup 12.50 pr
1928-31 Tudor sedan (doors)

A-19008-B 1930-31 Coupe 12.50 pr
A-19008-C 1928-31 Tudor sedan (quarter windows) 12.50 pr
A-19008-4DF 1928-30 Fordor (front door) and Cabriolet 20.00 ea
A-19008-4DR 1928-30 Fordor (rear doors) 20.00 ea

1928-31 Coupe, Tudor, 30-31 PU Door Garnish Screws
Note: Included in interior trim screw kits when needed.

A-342-S Door garnish screws 0.25 ea
A-45883-MB Door top cover screw set 1.50 ea
A-45890-MB Door opening header screw set 1.50 ea

**1928-31 Coupe Quarter Window Garnish Moldings,
Fiberglass**



CG2829Q 1928-29 Coupe, RH or LH 85.00 ea
CG3031RQ 1930-31 Coupe, RH 85.00 ea
CG3031LQ 1930-31 Coupe, LH 85.00 ea

**1928-31 Tudor Sedan
Quarter Window
Garnish Moldings**

Upper
A-16051-UQ n.a
Lower
A-56050-Q 130.00 pr

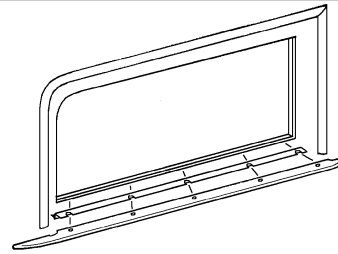

Finger Pulls on Garnish, Chrome Plated

A-61062-CR 1928-30 Cabriolet & Fordor sedan 10.00 ea

**1928-31 Coupe & Tudor Back
Window Garnish Molding
Fiberglass**

**1928-31 Coupe, Tudor
some Fordor Sedans**
RWM2831CS 90.00 ea



1928-31 Pickup Back Window Garnish Moldings

A-83820-AR 1928-29 Pickup, stamped steel 35.00 ea
RWM3034PU 1930-31 Pickup, fiberglass 130.00 ea



1926-31 Window Parts, cont

1930-31 Victoria Door Header Panels

The panels on the body above door.

A-45891-VCR	RH, cloth back Victoria	170.00	ea
A-45891-VCL	LH, cloth back Victoria	170.00	ea
A-45891-VSR	RH, steel back Victoria	80.00	ea
A-45891-VSL	LH, steel back Victoria	80.00	ea

1930-31 Victoria Window Garnish Moldings

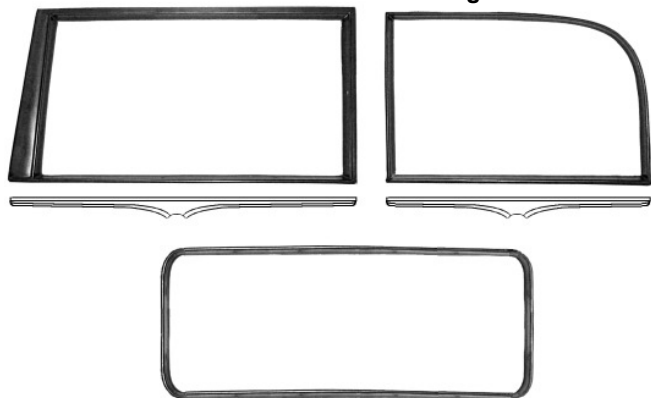

CG3031VDR	Door window frame, RH, fiberglass	n.a	
CG3031VDL	Door window frame, LH, fiberglass	n.a	
A-542-BVR	Door window lower trim, RH, steel	110.00	ea
A-542-BVL	Door window lower trim, LH, steel	110.00	ea
CG3031VQR	Quarter window frame, RH, fiberglass	n.a	
CG3031VQL	Quarter window frame, LH, fiberglass	n.a	
A-542-BVQ	Quarter window lower trim, RH or LH, steel	95.00	ea
RWM3031V	Back window frame, fiberglass	n.a	

1931 Fordor Sedan Door Window Garnish Lower Trim

A-542-BFD	1931 Fordor ft door: RH or LH	95.00	ea
A-542-BRD	1931 Fordor rear door: RH or LH	95.00	ea
A-542-BQ	1931 Fordor quarter: RH or LH	85.00	ea

Door Window Garnish Molding Tube Nut Sets

Note: Included in interior trim screw kits when needed.

AH-1102	8-32, set of 10, 1931 Slant Windshield	5.00	set
AH-1103	6-32, set of 6, 1928-30 Briggs Fordor	5.00	set

1926-31 Window Parts, cont

Typical 1926-31 Coupe, Tudor & Pickup Window Parts

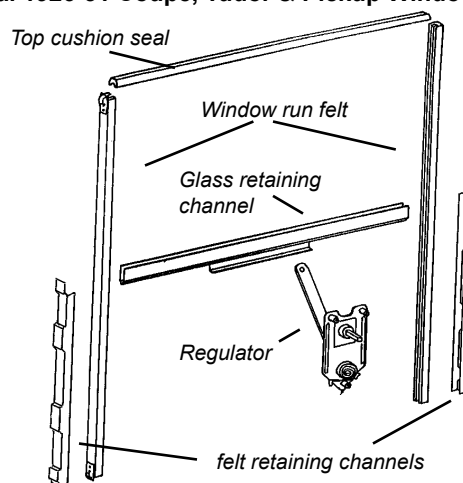

1926-31 Roll-Up Window Felt Kits

Includes window run felt channels for 2 windows, both right and left sides. Felt channels have attaching clips installed. Window top seals and adhesive are included. Regulator and glass retaining channels not included.

A-45983-PU	1926-27 Coupe & Tudor, 1928-29 Pickup cab	45.00	ea
A-45983-A	1928-31 Tudor, 1928-29 Coupe, 1930-31 PU	45.00	ea
A-45983-B	1930-31 Coupe	45.00	ea
A-45983-4D	1928-30 Fordor front doors	45.00	ea
A-45983-V	1931 Victoria & Fordor front doors	50.00	ea
A-46108	1930-31 Coupe back window	20.00	ea
A-56786	1928-31 Tudor quarter windows	45.00	ea
B-56786-V	1930-31 Victoria quarter windows	57.50	ea
A-56791-A	1928-30 Fordor rear doors	60.00	ea
A-56791-B	1931 Fordor rear door & quarter	70.00	ea

Window Glass Top Cushion Only

Note: Top cushion is included in window felt kits when needed.

A-45983-T	1928-31 (1 required per window)	2.50	ea
T-8399-T	1926-27 Tudor sedan quarter window	5.00	ea

1926-31 Window Regulators

1926-31 Coupe, Tudor (door or quarter), and Pickup

A-48105-A	Right side	32.50	ea
A-48106-A	Left side	32.50	ea

1928-30 Fordor sedan & Cabriolet

A-48105-B	RH front door, LH rear door	37.50	ea
A-48106-B	LH front door, RH rear door	37.50	ea

Window Regulator Repair Kits

Includes pinion gear, handle shaft, housing, clutch mechanism and spring, and 3 housing rivets. Ford had many suppliers so check number of pinion teeth and that the handle shaft housing mounts with 3 small rivets before ordering.

A-48105-ARK	1928-31 w/5 tooth pinion	22.50	ea
A-48105-BRK	1928-31 w/6 tooth pinion	12.50	ea

1926-31 Window Parts, cont**Window Glass Bottom Retaining Channels**

A-45962-PU	Doors: 1926-27 Coupe & Tudor, 1928-29 PU	27.50	ea
A-45962-S	Doors: 1928-31 Coupe & Tudor, 1930-31 PU	37.50	ea
A-45963-A	Doors: 1928-30 Fordor RH Front	10.00	ea
A-45963-B	Doors: 1928-30 Fordor LH Front	10.00	ea
B-45962	Door, RH or LH front: 1931 Fordor	27.50	ea
B-55962	Door, RH front: 1930-31 Victoria	32.50	ea
B-55963	Door, LH front: 1930-31 Victoria	32.50	ea
A-45963-A	Rear doors: 1928-30 Fordor LH	10.00	ea
A-45963-B	Rear doors: 1928-30 Fordor RH	10.00	ea
B-56789	Rear door, RH: 1931-34 Fordor	35.00	ea
B-56790	Rear door, LH: 1931-34 Fordor	35.00	ea
A-56787	Quarter: 1928-31 Tudor RH or LH	37.50	ea
A-45963-A	Quarter RH: 1930-32 Victoria, 1931-33 Fordor	10.00	ea
A-45963-B	Quarter LH: 1930-32 Victoria, 1931-33 Fordor	10.00	ea
B-47106	1930-34 Coupe with roll down back window	10.00	ea

Door Window Felt Retainer Channels

These are the channels that mount inside the doors that the window felt attaches to.

A-45970-A	RH front/LH back: 1928-29 Cpe/2D	12.50	ea
A-45971-A	LH front/RH back: 1928-29 Cpe/2D	12.50	ea
A-45970-B	RH or LH front: 1930-31 2D/PU	12.50	ea
A-45972-B	RH back: 1930-31 2D/PU	12.50	ea
A-45973-B	LH back: 1930-31 2D/PU	12.50	ea
A-45970-C	RH front: 1930-31 Cpe/SptCpe	12.50	ea
A-45971-C	LH front: 1930-31 Cpe/SptCpe	12.50	ea
A-45972-C	RH back: 1930-31 Cpe/SptCpe	12.50	ea
A-45973-C	LH back: 1930-31 Cpe/SptCpe	12.50	ea

Window Glass to Setting Channel with Body Seal**Fordor sedan, Victoria, & Cabriolet**

Sets glass into channel. When window is rolled up it is sealed to door or body. 6' length.

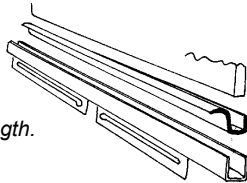

B-45968 10.00 ea

Window Glass to Frame Setting Tape

B-37193-A	all years, 20 ft, 1/32" thick	5.00	ea
B-37193-B	all years, 20 ft, 3/64" thick	7.50	ea
B-37193-C	all years, 20 ft, 1/16" thick	10.00	ea
B-37193-D	all years, 20 ft, 5/64" thick	10.00	ea

Fixed Quarter & Back Window Glass Rubber Channels

1926-36 Coupe & Sedan

B-704220 10' 15.00 ea

