

Universal Window Felt Parts

Door Window Felt Strips, Universal, 8' Strips

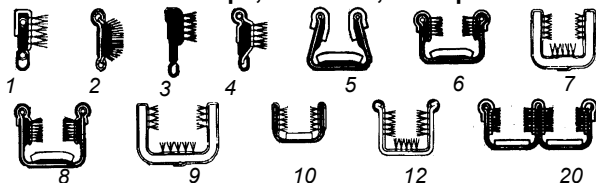

H-45983-1	Single side strip, black bead, 7/16	25.00	ea
H-45983-2	Single side strip, stainless bead, 7/16	17.50	ea
H-45983-3	Single side strip, black bead, 9/16	27.50	ea
H-45983-4	Single side strip, black, pile lined, 9/16	27.50	ea
H-45983-5	U shape, flexible, felt, black	35.00	ea
H-45983-6	U shape, flexible, felt & pile lined, black	35.00	ea
H-45983-7	U shape, flexible, pile lined, black	35.00	ea
H-45983-8	U shape, flex, felt & pile lined, stainless bead	35.00	ea
H-45983-9	U shape, flex, pile line, 7/16 to 1/2 glass	35.00	ea
H-45983-10	U shape, rigid, felt & pile lined, black	27.50	ea
H-45983-12	U shape, rigid, pile lined, stainless bead	35.00	ea
H-45983-20	Double U shape, flexible, pile & felt lined used on some station wagon sliding windows	45.00	ea

Window Glass to Frame Setting Tape

B-37193-A	All years, 20 ft, 1/32" thick	5.00	ea
B-37193-B	All years, 20 ft, 3/64" thick	7.50	ea
B-37193-C	All years, 20 ft, 1/16" thick	10.00	ea
B-37193-D	All years, 20 ft, 5/64" thick	10.00	ea

Window Felt Mounting Hardware

Sets of 25. these clips are included in complete window felt kits.

B-703536	Small headed screws, black, used to mount fuzzy strips to window openings when original hardware is not used	3.00	set
48-703536-A	Punch Clips used 1935-52	7.50	ea
48-703536-B	Garnish Clips used 1935-36	7.50	ea
78-703536	Staples used 1937-48	3.00	ea
11A-703536	V Clips used 1941-48	7.50	ea

1932-35 Window Glass Anti-Rattlers

Fits into holes in door, body, and garnish molding. Included in felt kits.

B-46044	Door or body	0.75	ea
B-45830	Garnish molding	0.50	ea

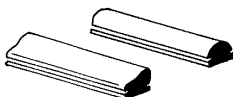

Window Glass Top Cushion Only

Note: Top cushion is included in window felt kits when needed.

A-45983-T	1928-31 (1 required per window)	2.50	ea
T-8399-T	1926-27 Tudor sedan quarter window	5.00	ea

Window Glass Bottom Rest Bumper

Included in felt kits.

B-48141	1926-34	0.75	ea
---------	---------	------	----

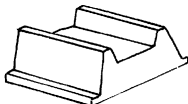

Power Window Regulators

"Geared" Power Window Kits by Specialty Power Windows

This kit features AC Delco motors and includes regulators, window glass bottom channels, necessary mounting brackets, control switches, and switch wire harnesses. Minimum 24" glass width.

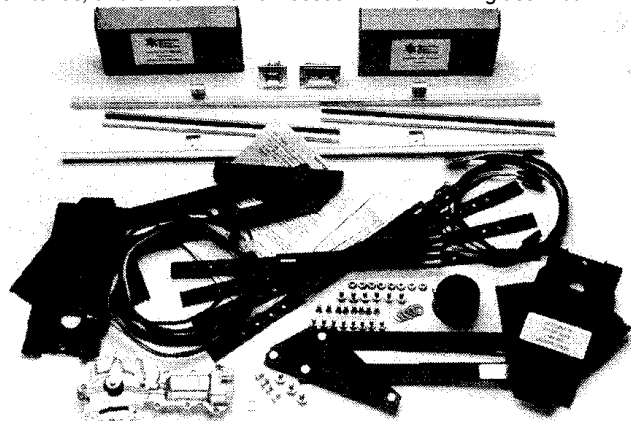

SPW-48100-A	2-Window, for Coupe, Convrt*, Pickup	450.00	set
SPW-48100-C	4-Window, for Sedan	825.00	set

*Convertibles may need fabrication of upper stops for proper glass top control.

Geared Regulator Kit for Model A

Specially designed for easy installation into 1928-31 Model A. These are single arm regulators. Kit includes wiring and switches.

SPW-48100-MA	2-Window, for Coupe & Pickup	450.00	ea
SPW-48100-MC	4-Window, for Sedan	825.00	ea

Wonder Lift Regulator Kits by Specialty Power Windows

This kit features Bosch motors and includes regulators, window glass bottom channels, necessary mounting brackets, control switches, and switch wire harnesses.

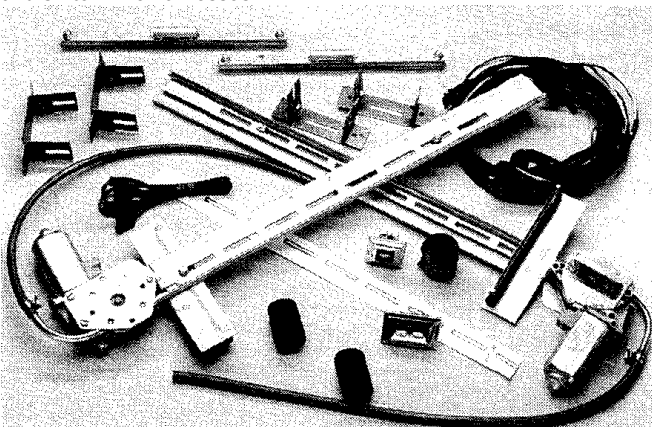

SPW-48100-LA	2-Window, for Coupe & Pickup	450.00	set
SPW-48100-LC	4-Window, for Sedan	825.00	set

Back Window Power Window Unit

We designed it for our 1932 3-Window Coupe, Specialty Power Windows makes it. Requires fabrication of a new mounting base plate to use on steel cars. Other fiberglass cars may need extra modifications to mount base plate and mount window channels.

SPW-48100-RW	Back Window Power Unit	275.00	ea
--------------	------------------------	--------	----

1935-47 Pickup Window Parts

Typical 1935-37 Pickup Window Parts

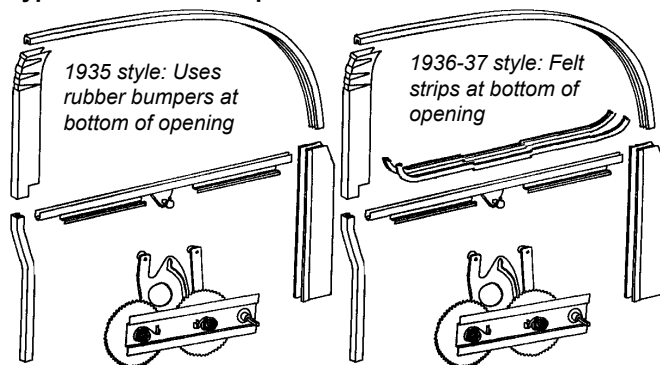

Roll-Up Window Felt Kits

The 1935-early 1936 used felt channel that went around the top and sides of the window and used rubber bumpers at the bottom. The late 1936-1937 used single sided felt at the bottom of the window opening. Each kit does two doors.

50-45983-PUA	1935-36, uses bumpers at window bottom	80.00	ea
50-45983-PUB	1936-37, uses felt all way around window	90.00	ea
01C-45983-PU	1938-47 Pickup & Truck	80.00	ea
81W-45983	1938-40 Cabover Truck	175.00	ea
11W-45983	1941-48 Cabover Truck	175.00	ea

Window Regulators

81C-812700/1	1938-47 Pickup, Panel, COE	175.00	pr
--------------	----------------------------	--------	----

Window Regulator Repair Kits

Includes small pinion gear, handle shaft, housing, clutch spring, and 3 housing rivets. Ford used different suppliers so check number of pinion teeth and for 3 rivets mounting shaft housing.

48-48105-WRK	w/6 tooth pinion	27.50	ea
--------------	------------------	-------	----

Door Window Glass Retaining Channels

50-702170	Door, RH: 1935-37 Pickup & Panel	35.00	ea
50-702171	Door, LH: 1935-37 Pickup & Panel	35.00	ea
81C-702170	Door, RH: 1938-46 Pickup	35.00	ea
81C-702171	Door, LH: 1938-46 Pickup	35.00	ea

Window Glass to Body Seal

Sets glass into channel. When window is rolled up it is sealed to door or body. 6' length.

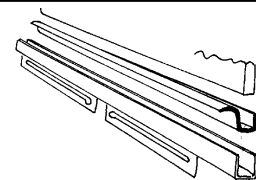

B-45968	10.00	ea
---------	-------	----

1933-39 Back Window Glass Rubber Channels

10' length

B-704220	15.00	ea
----------	-------	----

1935-39 Sliding Back Window Kit

Excellent reproduction of the rare original accessory

50-813396-K	1935-39 Pickup	200.00	ea
-------------	----------------	--------	----

1940-47 Back Window Seals

Ends seamed as original.

81C-704220-PD	1938-39 Panel delivery	40.00	ea
01A-704220-SD	1940-41 Sedan Delivery	40.00	ea
01C-704220-PU	1940-47 Pickup	30.00	ea
01C-704220-PD	1940-47 Panel delivery	40.00	pr