

Universal Window Felt Parts

Door Window Felt Strips, Universal, 8' Strips

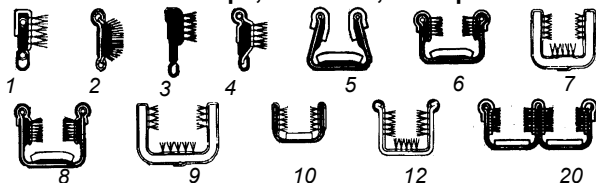

H-45983-1	Single side strip, black bead, 7/16	25.00	ea
H-45983-2	Single side strip, stainless bead, 7/16	17.50	ea
H-45983-3	Single side strip, black bead, 9/16	27.50	ea
H-45983-4	Single side strip, black, pile lined, 9/16	27.50	ea
H-45983-5	U shape, flexible, felt, black	35.00	ea
H-45983-6	U shape, flexible, felt & pile lined, black	35.00	ea
H-45983-7	U shape, flexible, pile lined, black	35.00	ea
H-45983-8	U shape, flex, felt & pile lined, stainless bead	35.00	ea
H-45983-9	U shape, flex, pile line, 7/16 to 1/2 glass	35.00	ea
H-45983-10	U shape, rigid, felt & pile lined, black	27.50	ea
H-45983-12	U shape, rigid, pile lined, stainless bead	35.00	ea
H-45983-20	Double U shape, flexible, pile & felt lined used on some station wagon sliding windows	45.00	ea

Window Glass to Frame Setting Tape

B-37193-A	All years, 20 ft, 1/32" thick	5.00	ea
B-37193-B	All years, 20 ft, 3/64" thick	7.50	ea
B-37193-C	All years, 20 ft, 1/16" thick	10.00	ea
B-37193-D	All years, 20 ft, 5/64" thick	10.00	ea

Window Felt Mounting Hardware

Sets of 25. these clips are included in complete window felt kits.

B-703536	Small headed screws, black, used to mount fuzzy strips to window openings when original hardware is not used	3.00	set
48-703536-A	Punch Clips used 1935-52	7.50	ea
48-703536-B	Garnish Clips used 1935-36	7.50	ea
78-703536	Staples used 1937-48	3.00	ea
11A-703536	V Clips used 1941-48	7.50	ea

1932-35 Window Glass Anti-Rattlers

Fits into holes in door, body, and garnish molding. Included in felt kits.

B-46044	Door or body	0.75	ea
B-45830	Garnish molding	0.50	ea

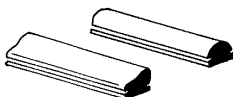

Window Glass Top Cushion Only

Note: Top cushion is included in window felt kits when needed.

A-45983-T	1928-31 (1 required per window)	2.50	ea
T-8399-T	1926-27 Tudor sedan quarter window	5.00	ea

Window Glass Bottom Rest Bumper

Included in felt kits.

B-48141	1926-34	0.75	ea
---------	---------	------	----

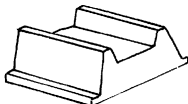

Power Window Regulators

"Geared" Power Window Kits by Specialty Power Windows

This kit features AC Delco motors and includes regulators, window glass bottom channels, necessary mounting brackets, control switches, and switch wire harnesses. Minimum 24" glass width.

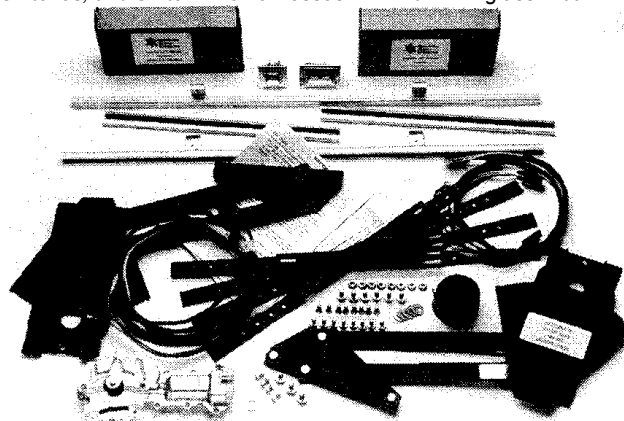

SPW-48100-A	2-Window, for Coupe, Convrt*, Pickup	450.00	set
SPW-48100-C	4-Window, for Sedan	825.00	set

*Convertibles may need fabrication of upper stops for proper glass top control.

Geared Regulator Kit for Model A

Specially designed for easy installation into 1928-31 Model A. These are single arm regulators. Kit includes wiring and switches.

SPW-48100-MA	2-Window, for Coupe & Pickup	450.00	ea
SPW-48100-MC	4-Window, for Sedan	825.00	ea

Wonder Lift Regulator Kits by Specialty Power Windows

This kit features Bosch motors and includes regulators, window glass bottom channels, necessary mounting brackets, control switches, and switch wire harnesses.

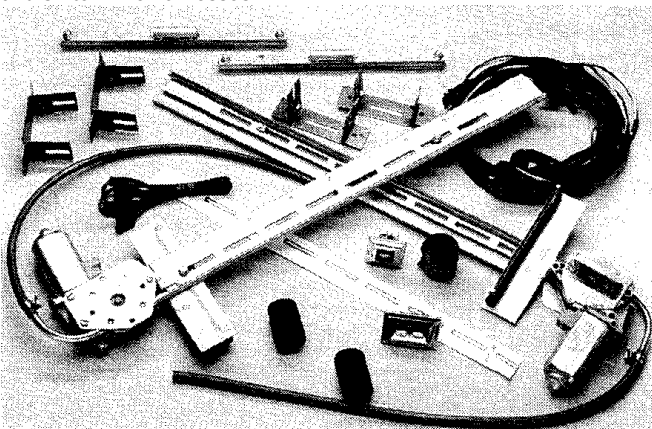

SPW-48100-LA	2-Window, for Coupe & Pickup	450.00	set
SPW-48100-LC	4-Window, for Sedan	825.00	set

Back Window Power Window Unit

We designed it for our 1932 3-Window Coupe, Specialty Power Windows makes it. Requires fabrication of a new mounting base plate to use on steel cars. Other fiberglass cars may need extra modifications to mount base plate and mount window channels.

SPW-48100-RW	Back Window Power Unit	275.00	ea
--------------	------------------------	--------	----

1937-39 Passenger Window Parts**1937-38 Garnish Molding Plastic Inserts**

78-7020988-A	1937 Standard, light brown	15.00	pr
78-7020988-B	1937 Deluxe, yellow brown	15.00	pr
81A-7020988-6	1938 Deluxe Coupe & Fordor	15.00	pr
81A-7020988-8	1938 Deluxe Tudor & Club coupe	15.00	pr

1939 Convertible Door Window Garnish Molding

Will also fit 1937-38 but detail is different.



CG39CNV	Fiberglass, fits RH or LH	120.00	ea
---------	---------------------------	--------	----

Door Interior Upholstery Former Panels

These are the light weight stamped steel panels used on 1935-40 Coupes and Sedans and are covered with upholstery and snap to the inside of the doors around the window.

91A-7323810/11B	1937-40 Standard Coupe, Fordor front	62.50	pr
-----------------	--------------------------------------	-------	----

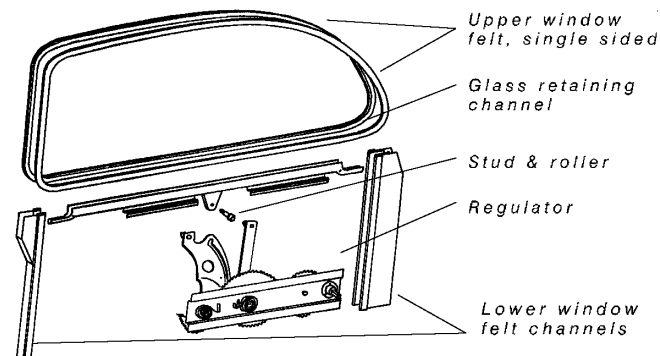
Typical 1937-39 Coupe & Sedan Window Parts**1937-39 Roll-Up Window Felt Kits**

Kits includes lower felt channels with clips attached, pre-bent upper window single sided felt, and installation clips & screws for 2 windows. Regulator and glass retaining channels not included.

Door window felt kits

78-45983-2D	1937-39 Tudor & 5-Pass coupe door windows	100.00	ea
78-45983-4D	1937-39 Coupe & Fordor front door windows	100.00	ea
78-56791	1937-38 Fordor rear door windows	67.50	ea
91A-56791	1939-40 Fordor rear door windows	67.50	ea

Quarter window felt kits

78-56786	1937 Tudor quarter windows	90.00	ea
81A-56786	1938-40 Tudor quarter windows	90.00	ea

Convertible Window Special Parts

01A-6622218	Window Glass Frame Roller Rebuild Kit (4 rollers, 4 axle pins, and springs to rebuild one window)	90.00	set
48-762232	Glass to window stainless frame setting channel	10.00	ea

Window Regulator Repair Kits

Includes small pinion gear, handle shaft, housing, clutch spring, and 3 housing rivets. Ford used different suppliers so check number of pinion teeth and for 3 rivets mounting shaft housing.

48-48105-WRK	1935-39 w/6 tooth pinion	27.50	ea
B-48105-WRK	1935-39 Tudor Quarter w/10 tooth pinion	32.50	ea

1937-39 Pass Window Parts, cont**Window Glass Retaining Channels**

78-702170-A	Door, RH: Tudor & Club cpe	35.00	ea
78-702171-A	Door, LH: Tudor & Club cpe	35.00	ea
78-702170-B	Door, RH: Coupe & Fordor	35.00	ea
78-702171-B	Door, LH: Coupe & Fordor	35.00	ea
78-56789	Door, RH/LH rear: 1937-40 Fordor	35.00	ea
40-702170	Quarter: RH: 1934-40 Tudor	35.00	ea
40-702171	Quarter: LH: 1934-40 Tudor	35.00	ea
48-45962-STUD	Roller and stud for window channels	17.50	pr

Window Glass to Body Seal

Sets glass into channel. When window is rolled up it is sealed to door or body. 6' length.

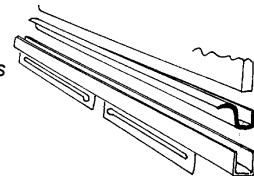

B-45968	10.00	ea
---------	-------	----

Quarter Window Rubber Seals**5 Window Coupe**

78-704220-S	molded, 1pc	20.00	pr
-------------	-------------	-------	----

Fordor Sedan Quarter Window

81A-7329904-PR	popout, 1 pc	100.00	pr
78-735130	1938 Deluxe, 1939 fixed style, length	50.00	ea

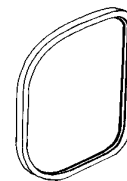
**Fordor Sedan Popout Quarter Window Handles and Pivot**

78-735280	Window handle, chrome, RH	35.00	ea
78-735281	Window handle, chrome, LH	35.00	ea
01A-7022938	Window handle pivot shaft & bkt	15.00	ea

Coupe & Sedan Back Window Seals (Ford & Mercury)**1937-1940 Coupes****1937 & 1938 Standard Sedan**

78-704220	25.00	pr
-----------	-------	----

1938 Deluxe & 1939-40 Sedan

81A-704220	25.00	pr
------------	-------	----

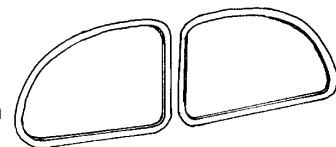
**1939-40 Wescott Convertible Window Glass & Channels**

Street rod type, tempered frameless glass. Vent window not available. Channel kit fits cars with Wescott's steel door inner reinforcement structures. Requires some modifications to fit 1935-40 steel doors. Specialty Power regulators recommended.

Tempered glass: specify color: gray -CT, solex green -CG, clear -CP

91A-45900-xx	Stock height glass	350.00	pr
91A-45900-xx2	2" chop glass	350.00	pr
91A-45983-WC	Channel kit (Wescott's)	125.00	set
91A-45983-CNV	Door top felt strips, set of 4	70.00	set

Installation only available on Wescott body during body assembly.