

### Universal Window Felt Parts

#### Door Window Felt Strips, Universal, 8' Strips

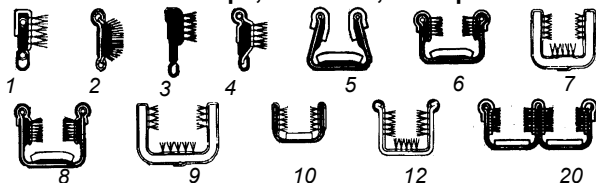

H-45983-1	Single side strip, black bead, 7/16	25.00	ea
H-45983-2	Single side strip, stainless bead, 7/16	17.50	ea
H-45983-3	Single side strip, black bead, 9/16	27.50	ea
H-45983-4	Single side strip, black, pile lined, 9/16	27.50	ea
H-45983-5	U shape, flexible, felt, black	35.00	ea
H-45983-6	U shape, flexible, felt & pile lined, black	35.00	ea
H-45983-7	U shape, flexible, pile lined, black	35.00	ea
H-45983-8	U shape, flex, felt & pile lined, stainless bead	35.00	ea
H-45983-9	U shape, flex, pile line, 7/16 to 1/2 glass	35.00	ea
H-45983-10	U shape, rigid, felt & pile lined, black	27.50	ea
H-45983-12	U shape, rigid, pile lined, stainless bead	35.00	ea
H-45983-20	Double U shape, flexible, pile & felt lined used on some station wagon sliding windows	45.00	ea

#### Window Glass to Frame Setting Tape

B-37193-A	All years, 20 ft, 1/32" thick	5.00	ea
B-37193-B	All years, 20 ft, 3/64" thick	7.50	ea
B-37193-C	All years, 20 ft, 1/16" thick	10.00	ea
B-37193-D	All years, 20 ft, 5/64" thick	10.00	ea

#### Window Felt Mounting Hardware

Sets of 25. these clips are included in complete window felt kits.

B-703536	Small headed screws, black, used to mount fuzzy strips to window openings when original hardware is not used	3.00	set
48-703536-A	Punch Clips used 1935-52	7.50	ea
48-703536-B	Garnish Clips used 1935-36	7.50	ea
78-703536	Staples used 1937-48	3.00	ea
11A-703536	V Clips used 1941-48	7.50	ea

#### 1932-35 Window Glass Anti-Rattlers

Fits into holes in door, body, and garnish molding. Included in felt kits.

B-46044	Door or body	0.75	ea
B-45830	Garnish molding	0.50	ea

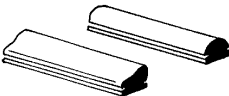

#### Window Glass Top Cushion Only

Note: Top cushion is included in window felt kits when needed.

A-45983-T	1928-31 (1 required per window)	2.50	ea
T-8399-T	1926-27 Tudor sedan quarter window	5.00	ea

#### Window Glass Bottom Rest Bumper

Included in felt kits.

B-48141	1926-34	0.75	ea
---------	---------	------	----

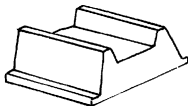

### Power Window Regulators

#### "Geared" Power Window Kits by Specialty Power Windows

This kit features AC Delco motors and includes regulators, window glass bottom channels, necessary mounting brackets, control switches, and switch wire harnesses. Minimum 24" glass width.

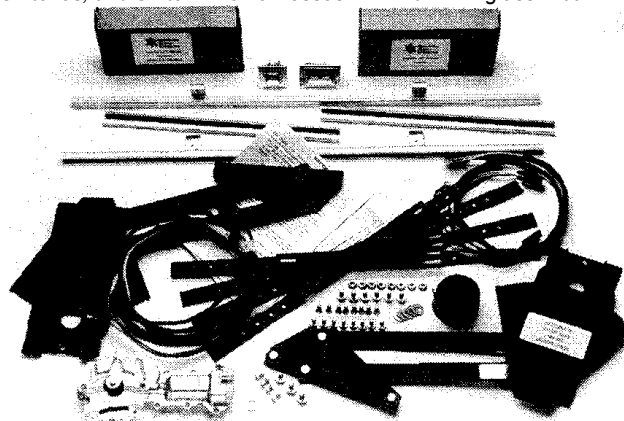

SPW-48100-A	2-Window, for Coupe, Convrt*, Pickup	450.00	set
SPW-48100-C	4-Window, for Sedan	825.00	set

\*Convertibles may need fabrication of upper stops for proper glass top control.

#### Geared Regulator Kit for Model A

Specially designed for easy installation into 1928-31 Model A. These are single arm regulators. Kit includes wiring and switches.

SPW-48100-MA	2-Window, for Coupe & Pickup	450.00	ea
SPW-48100-MC	4-Window, for Sedan	825.00	ea

#### Wonder Lift Regulator Kits by Specialty Power Windows

This kit features Bosch motors and includes regulators, window glass bottom channels, necessary mounting brackets, control switches, and switch wire harnesses.

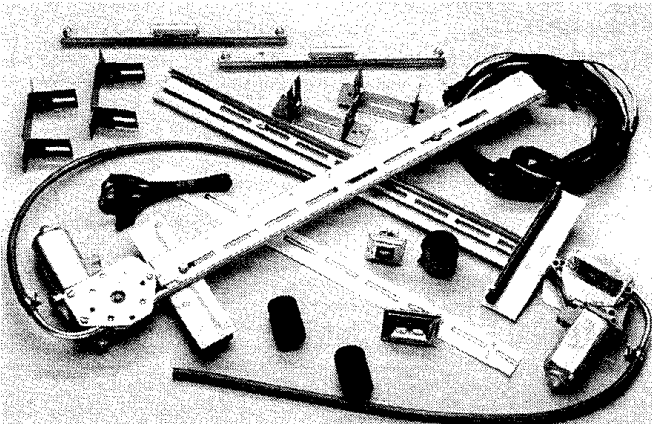

SPW-48100-LA	2-Window, for Coupe & Pickup	450.00	set
SPW-48100-LC	4-Window, for Sedan	825.00	set

#### Back Window Power Window Unit

We designed it for our 1932 3-Window Coupe, Specialty Power Windows makes it. Requires fabrication of a new mounting base plate to use on steel cars. Other fiberglass cars may need extra modifications to mount base plate and mount window channels.

SPW-48100-RW	Back Window Power Unit	275.00	ea
--------------	------------------------	--------	----

### 1940 Passenger Window Parts

#### 1940 Convertible Door Window Garnish Molding



CG39CNV      Fiberglass, fits RH or LH      120.00 ea

#### Door Interior Upholstery Former Panels

These are the light weight stamped steel panels used on 1935-40 Coupes and Sedans and are covered with upholstery and snap to the inside of the doors around the window.

91A-7323810/11B      1937-40 Standard Coupe, Fordor front      62.50 pr

#### Typical 1940 Coupe & Sedan Window Parts

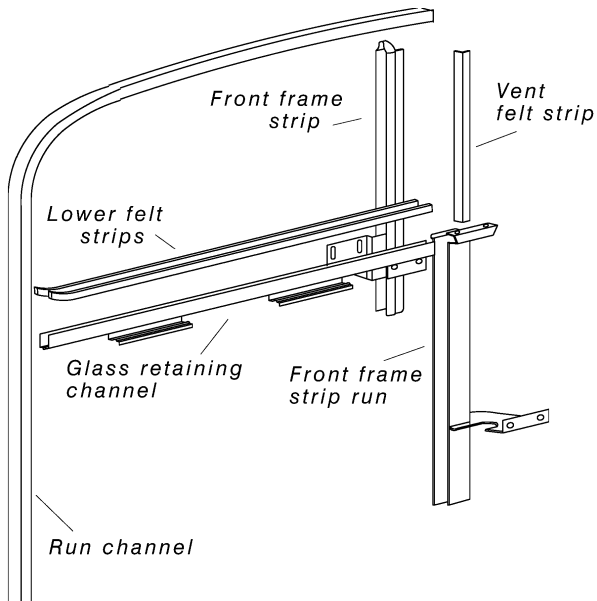

#### 1940 Roll-Up Window Felt Kits

Kits include felt U channels and lower felted channels with clips attached and single sided felt with original type installation clips and screws for 2 windows. Passenger front door kits do not include felt strip for front stainless frame strip.

01A-45983-2D	1940 Tudor sedan door windows	90.00	ea
81A-56786	1938-40 Tudor quarter windows	90.00	ea
01A-45983-4D	1940 Coupe & Fordor front door windows	80.00	ea
91A-56791	1939-40 Fordor rear door windows	67.50	ea
01A-45983-C	1940 Convertible door windows	50.00	ea

#### 1940 Front Door Vent Window to Door Window Strip

\*\*\* Window felt kits DO NOT include vent window felt strip. \*\*\*

01A-7022296-A	Convertible, Rubber	22.50	pr
01A-7022296	Coupe/Sedan, fuzz	22.50	pr

#### Convertible Window Special Parts

01A-6622218	Window Glass Frame Roller Rebuild Kit (4 rollers, 4 axle pins, and springs to rebuild one window)	90.00	set
48-762232	Glass to window stainless frame rubber	10.00	ea

#### Front Door Vent Window Parts

99A-7621448-S	Rubber seals, 1939-40 Mercury Convertible	175.00	pr
99A-7021448-S	Rubber seals, 1939-40 Mercury Coupe/Sedan	175.00	pr
01A-6621448-S	Rubber seals, 1940 Ford Convertible	100.00	pr
01A-7021448-S	Rubber seals, 1940 Ford Coupe & Sedan	100.00	pr
01A-7022916/7	Handle, w/center button, chrome	65.00	pr
01A-7022938	Handle pivot shaft and bracket	15.00	ea

### 1940 Passenger Window Parts, cont

#### Window Regulators

01A-7323200/1	1940 Coupe, Fordor front	175.00	pr
01A-7023200/1	1940 Tudor (front)	175.00	pr

#### Window Regulator Repair Kits

Includes small pinion gear, handle shaft, housing, clutch spring, and 3 housing rivets. Ford used different suppliers so check number of pinion teeth and for 3 rivets mounting shaft housing.

01A-48105-WRK	1940-48 Passenger w/6 tooth pinion	25.00	ea
B-48105-WRK	1940 Tudor quarter window w/10 tooth pinion	32.50	ea
48-48105-WRK	1940-41 Pickup w/6 tooth pinion	27.50	ea

#### Window Glass Retaining Channels

01A-702170-A	RH front: 1940 Tudor sedan	35.00	ea
01A-702171-A	LH front: 1940 Tudor sedan	35.00	ea
01A-702170-B	RH front: 1940 Coupe & Fordor	35.00	ea
01A-702171-B	LH front: 1940 Coupe & Fordor	35.00	ea
78-56789	Door, RH/LH rear: 1937-40 Fordor	35.00	ea
40-702170	Quarter: RH: 1934-40 Tudor	35.00	ea
40-702171	Quarter: LH: 1934-40 Tudor	35.00	ea

#### Window Glass to Frame Setting Tape

B-37193-A	all years, 20 ft, 1/32" thick	5.00	ea
B-37193-B	all years, 20 ft, 3/64" thick	7.50	ea
B-37193-C	all years, 20 ft, 1/16" thick	10.00	ea
B-37193-D	all years, 20 ft, 5/64" thick	10.00	ea

#### Quarter Window Rubber Seals

##### 5 Window Coupe

Ends seamed as original.

78-704220-S      20.00 pr

##### Fordor Sedan Quarter Window

81A-7329904-PR	popout, 1 pc	100.00	pr
	1938 Deluxe, 1939		
78-735130	fixed style, length	50.00	ea

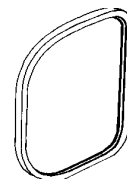

#### Fordor Sedan Popout Quarter Window Handles and Pivot

78-735280	Window handle, chrome, RH	35.00	ea
78-735281	Window handle, chrome, LH	35.00	ea
01A-7022938	Window handle pivot shaft & bkt	15.00	ea

#### Coupe & Sedan Back Window Seals (Ford & Mercury)

##### 1937-1940 Coupes

78-704220      25.00 pr

##### Sedans

81A-704220      25.00 pr

##### 1940-41 Sedan Delivery

01A-704220-SD      40.00 ea

