

**Latches, Dovetails & Bumpers, cont**

**Doors: 1917-27 Roadster & Touring**

**1916-17 Door latches**

with early straight handle:

T-1001	RH front, LH rear	75.00 ea
T-1002	RH rear	75.00 ea

**1917-26 Door Latches**

with stock plain bent handle fits 1926 style doors with side curtain socket integral in door

T-1003	RF, LR (1917-25), RR (1926)	75.00 ea
T-1004	LF, RR (1917-25), LR (1926)	75.00 ea

**1917-26 Door Latches**

with chrome 1928 style handle fits 1926 style doors with side curtain socket integral in door

T-1003-CH	RF, LR (1917-25), RR (1926)	100.00 ea
T-1004-CH	LF, RR (1917-25), LR (1926)	100.00 ea

**1927 with stock plain bent handle**

Latch has side curtain socket integral with latch

T-1005	RH front or rear	90.00 ea
T-1006	LH front or rear	90.00 ea

**Latch Striker Plates**

1917-27 used a striker with a integral wedge. The 1928-32 style without wedge makes a nice replacement

A-35705	Plain	16.00 ea
A-35705-SS	Stainless	15.00 ea

**Door rubber bumpers and dovetails**

Not used on 1916-27 Roadsters or Tourings

**Doors:**

**1926-27 Coupe & Sedan  
1928-29 Pickup**

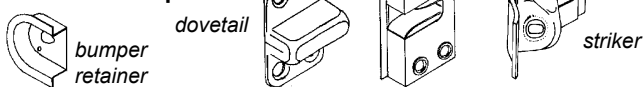

A-702610-NS	Door rubber bumper kit	10.00 set
A-80332	Door Jamb Bumper Retainer (28-29 PU only)	4.00 ea
A-76819	Male dovetail, chrome plated	2.50 ea
A-80333	Dovetail Socket: 1928-29 Pickup	12.50 ea
A-80055-AR	Door latch: RH	n.a
A-80056-AR	Door latch: LH	n.a
A-80055-RK	Latch repair: Spring & rivet kit for both sides	17.50 ea
A-80331	Door latch striker	12.50 ea

**Trunk Lid: 1926-27  
Roadster & Coupe**

**Latch, original style**

T-9545-L	25.00 ea
----------	----------

**Latch Key, Chrome Plated**

Used to unlatch and lift open lid

T-9484-B	10.00 ea
----------	----------

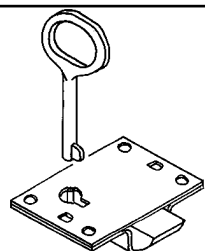

**Latches, Dovetails & Bumpers cont**

**Doors: 1928-31 Roadster & Phaeton**

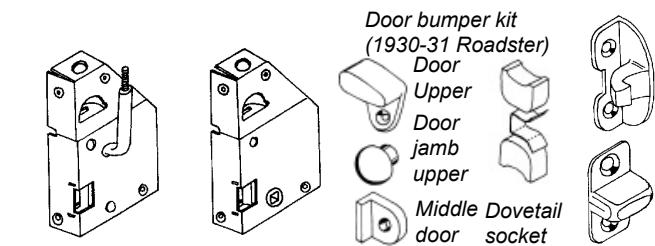

A-702610-ES	Door bumper kit: 1928-29 Roadster & RPU	10.00 set
A-702610-FS	Door bumper kit: 1930-31 Roadster & RPU	10.00 set
A-702610-KS	Door bumper kit: 1928-29 Phaeton	15.00 set
A-702610-LS	Door bumper kit: 1930-31 Fordor phaeton	15.00 set
A-46419-S	Door dovetail	3.00 ea
A-35655-AR	Door latch: RH, 1928 w/chrome inside handle	100.00 ea
A-35656-AR	Door latch: LH, 1928 w/chrome inside handle	100.00 ea
A-35655-B	Door latch: RH, 1929-31, uses outside handle	100.00 ea
A-35656-B	Door latch: LH, 1929-31, uses outside handle	100.00 ea
A-35705	Latch striker, steel	10.00 ea
A-35705-SS	Latch striker, stainless	15.00 ea
B-35705-S	Latch striker screws	1.50 set

**Doors: 1928-31 Coupe & Tudor, 1930-31 Pickup**

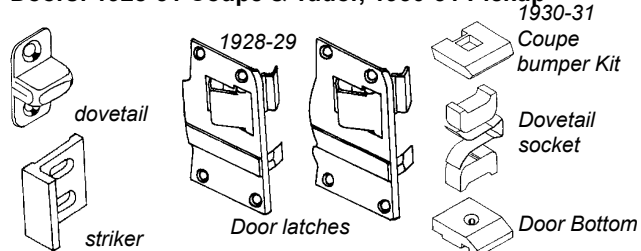

A-702610-AS	Door bumper kit: 1928-29	10.00 set
A-702610-BS	Door bumper kit: 1930-31	12.50 set
A-46419-S	Door dovetail	3.00 ea
A-46105-A	Door latch: RH, 1928-29	27.50 ea
A-46106-A	Door latch: LH, 1928-29	30.00 ea
A-46105-B	Door latch: RH, 1930-31	27.50 ea
A-46106-B	Door latch: LH, 1930-31	30.00 ea
A-46125	Latch repair: Spring kit for both sides	10.00 set
A-46137	Latch striker plate: plain	5.00 ea
A-46158-AS	Latch to inside handle rod set: 1928-29 Coupe 1930-31 Tudor & Pickup	30.00 set
A-46158-BS	Latch to inside handle rod set: 1930-31 Coupe	30.00 set
A-46195-S	Door to latch rod clips set/4	10.00 set

**Doors: 1929-30 Fordor and Cabriolet**

A-702610-CS	Door bumper kit: 1928-30 Fordor sedan	15.00 set
A-702610-HS	Door bumper kit: 1930 Cabriolet	10.00 set
A-61419-A	Dovetail, chrome: 1929-30, (4 mt holes)	17.50 ea
A-61412	Dovetail Socket: 1929-30 Cabr./Fordor	15.00 ea
A-61106-R	Latch: RH front, LH rear	n.a
A-61106-L	Latch: LH front, RH rear	n.a

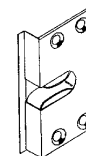

**Latches, Dovetails & Bumpers, cont**

**Doors: 1930-31 Victoria, 1931 Fordor and Cabriolet**

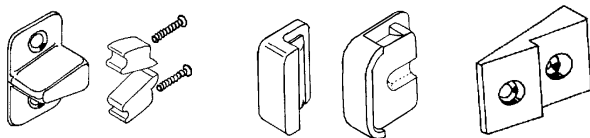

A-702610-TS	Door bumper kit: 1931 Cabriolet	15.00	set
B-46440	Door bumpers (each): 1931 Fordor	1.75	ea
B-191442	Door bumpers (each): Victoria & Conv Sedan	3.00	ea
B-46421	Dovetail, 1931, (stainless)	7.50	ea
48-702574-RK	Dovetail socket repair kit	7.50	ea
A-161100-BR	Latch: RH front, LH rear	n.a	
A-161101-BR	Latch: LH front, RH rear	n.a	
B-46137-A	Latch striker, plain: 31 Fordor	7.50	ea
40-702340-SS	Latch striker, stainless: 31 Fordor	10.00	ea
48-702336-A	Latch striker nut plate: 31 Fordor	12.50	pr
B-46125	Door latch repair: spring	3.00	ea
B-702269	Door latch repair: spring retainer clip	4.00	ea
B-702268	Inside handle shaft tension spring	5.00	ea

**1930-31 Deluxe (Tudor) Phaeton**

A-180652-R	Latch: RH	n.a	
A-180653-R	Latch: LH	n.a	

**Rumble Lid: 1928-31 Coupe Roadster & Cabriolet**

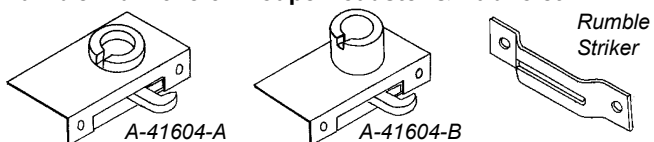

A-41604-A	Latch: 1928-29	50.00	ea
A-41604-B	Latch: 1930-31	50.00	ea
A-52500	Striker Plate: 1928-31	3.00	ea
B-41518	Upper (round) bumpers, 3/4" tall	5.00	pr
B-41518-T	Upper (round) bumpers, 7/8" tall	5.00	pr
B-41484	Lower stop (rectangular) bumpers	7.50	pr
A-41585-AS	Lower stop bracket kit (w/bumpers) 1928-29	17.50	ea
A-41585-BS	Lower stop bracket kit (w/bumpers) 1930-31	17.50	set

**Trunk Lid: 1928-31 Coupe Roadster & Cabriolet**

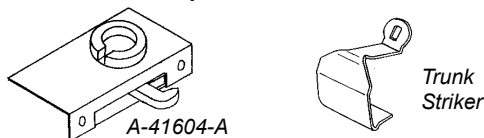

A-41604-A	Latch:	50.00	ea
A-41615	Striker plate	7.50	ea
B-41518	Lower (round) bumpers, 3/4" tall	5.00	pr
B-41518-T	Lower (round) bumpers, 7/8" tall	5.00	pr

**Station Wagon**

A-702610-SS	1928-31 Door bumper kit	25.00	set
B-151444	Door rubber bumpers, 1928-39	3.00	ea
91A-7943916	Tailgate bumpers, 1939-41	22.50	pr
21A-7943916	Tailgate bumpers, 1942-48	22.50	pr

**Latches, Dovetails & Bumpers cont**

**Doors: 1932 5 Window, Tudor, Victoria, Fordor 1932-34 Pickup**

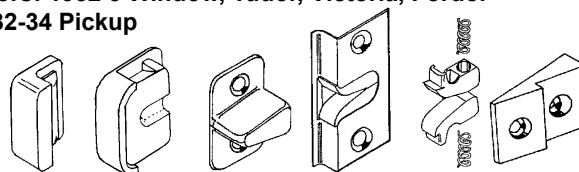

B-46440	Door bumpers: 5 Window, Tudor, Pickup	1.75	ea
B-191442	Door bumpers: Victoria & Convertible	3.00	ea
	Rear door bumpers: Panel & Sedan Delivery		
B-46421	Dovetail, stainless	7.50	ea
B-46421-S	Dovetail mounting screws	1.00	set
B-46412-BS	Dovetail socket: Plain	17.50	pr
B-46412-SS	Dovetail socket: Stainless	25.00	pr
B-702574-RK	Dovetail socket repair kit	7.50	ea
B-46137-A	Latch striker, plain	7.50	ea
40-702340-SS	Latch striker, stainless	10.00	ea
48-702336-A	Latch striker nut plate	12.50	pr
B-46105-B	Latch: RH	n.a	
B-46106-B	Latch: LH	n.a	
B-46125	Door latch repair: spring	3.00	ea
B-702269	Door latch repair: spring retainer clip	4.00	ea
B-702268	Inside handle shaft tension spring	5.00	ea

**Doors: 1932 Roadster & Phaeton**

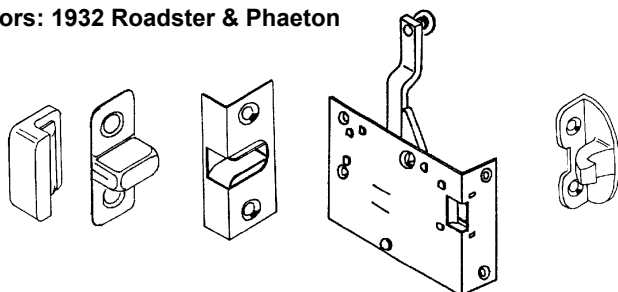

B-46440	Door bumpers	1.75	ea
B-35582	Dovetail, stainless	7.50	ea
B-35582-S	Dovetail mounting screws	1.00	set
B-35576-AS	Dovetail socket: Plain	17.50	pr
B-35576-SS	Dovetail socket: Stainless	25.00	pr
B-35655	Door Latch: RH front, (phaeton LH rear)	100.00	ea
B-35656	Door Latch: LH front, (phaeton RH rear)	100.00	ea
A-35705	Latch striker, steel	10.00	ea
A-35705-SS	Latch striker, stainless	15.00	ea
B-35705-S	Latch striker screws	1.50	set

**Rumble Lid: 32 5 Window Coupe, Roadster & Cabriolet**

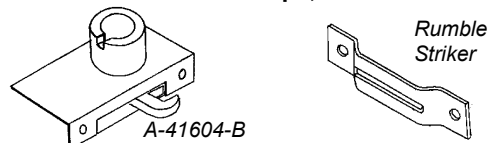

A-41604-A	Latch:	50.00	ea
A-52500	Striker Plate: 1928-31	3.00	ea
B-41518	Upper (round) bumpers, 3/4" tall	5.00	pr
B-41518-T	Upper (round) bumpers, 7/8" tall	5.00	pr
B-41484	Lower stop (rectangular) bumpers	7.50	pr
B-714008-S	Lower stop bracket kit (w/bumpers)	15.00	set

**Latches, Dovetails & Bumpers, cont**

**Trunk Lid: 1928-31 Coupe Roadster & Cabriolet**

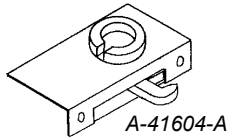

A-41604-A	Latch:	50.00	ea
A-41615	Striker plate	7.50	ea
B-41518	Lower (round) bumpers, 3/4" tall	5.00	pr
B-41518-T	Lower (round) bumpers, 7/8" tall	5.00	pr

**Remote Latches for 1928-34 Coupes and Roadsters**

On Wescott's Roadster bodies with a remote rumble or trunk latch, we use a 1932 3-Window rumble latch (B-527102) and an adjustable striker (B-52500-RR) on the deck lid. These can be used on most 1928-34 Roadsters and Coupes. When used as a rumble latch the spacer adaptor (B-527103) is welded to the upper drip channel or reinforcing. Trunk lid use requires a lower drip channel with modifications molded in. Some modifications may be needed to the lower drip channel when installing.

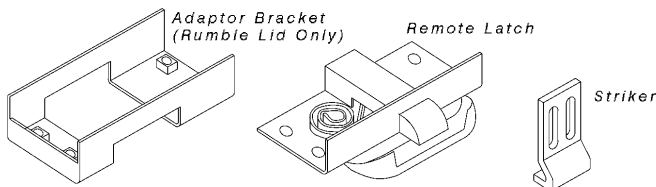

**Latch & striker:**

B-527102	Remote latch	25.00	ea
B-52500-RR	Adjustable striker	10.00	ea
B-527103	Adaptor to rumble upper drip rail	12.50	ea

**Lower drip channels for remote trunk latch, fiberglass:**

RDC32R	1928-32 Roadster & 5-Window coupe	265.00	ea
RDC32W3	1932 3-Window coupe	265.00	ea
RDC3334R	1933-34 Roadster & Coupe	265.00	ea

**Doors: 1932 3 Window**

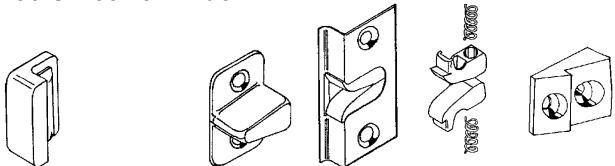

B-46440	Door bumpers	1.75	ea
B-46421	Dovetail, stainless	7.50	ea
B-46421-S	Dovetail mounting screws	1.00	set
B-46412-BS	Dovetail socket: Plain	17.50	pr
B-46412-SS	Dovetail socket: Stainless	25.00	pr
B-702574-RK	Dovetail socket repair kit	7.50	ea
B-522800	Door latch, RH	300.00	ea
B-522801	Door latch, LH	300.00	ea
B-46137-B	Door latch striker, plain	7.50	ea
B-46125	Door latch repair: spring	3.00	ea
B-702269	Door latch repair: spring retainer clip	4.00	ea

**Latches, Dovetails & Bumpers, cont**

**Doors: 1933-34 Coupe, Sedan, Convertible**

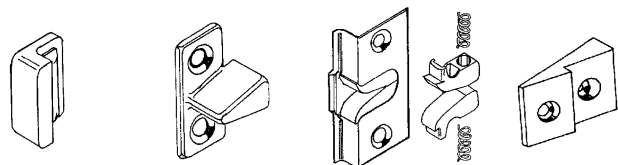

B-46440	Door bumpers	1.75	ea
40-702550-D	Dovetail, stainless	7.50	ea
40-702550-S	Dovetail mounting screws	1.00	set
40-46412-BS	Dovetail socket: Plain	35.00	pr
40-46412-SS	Dovetail socket: Stainless	40.00	pr
B-702574-RK	Dovetail socket repair kit	7.50	ea
B-46137-A	Latch striker, plain	7.50	ea
40-702340-SS	Latch striker, stainless	10.00	ea
48-702336-A	Latch striker nut plate	12.50	pr
40-702250-B	Latch: RH, 1933	n.a	
40-702251-B	Latch: LH, 1933	n.a	
40-702250-C	Latch: RH, 1934	n.a	
40-702251-C	Latch: LH, 1934	n.a	
40-702267-B	Door latch repair: spring	2.00	ea
B-702269	Door latch repair: spring retainer clip	4.00	ea
B-702268	Inside handle shaft tension spring (1934)	5.00	ea

**Doors: 1933-36 Roadster & Phaeton**

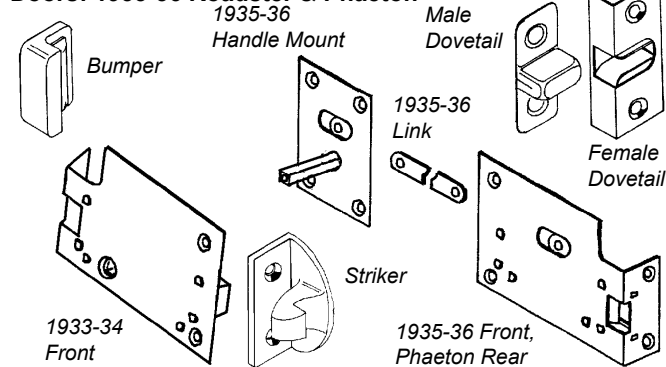

B-46440	Door bumpers	1.75	ea
40-712018	Dovetail, stainless	12.50	ea
B-35582-S	Dovetail mounting screws	1.00	set
B-35576-AS	Dovetail socket: Plain	17.50	pr
B-35576-SS	Dovetail socket: Stainless	25.00	pr
40-711800	Door Latch: 1933-34: RH front	100.00	ea
40-711801	Door Latch: 1933-34: LH front	100.00	ea
48-711800	Door Latch: 1935-36 RH front or Rear, 1933-34 Phaeton RH Rear	100.00	ea
48-711801	Door Latch: 1935-36 LH front or Rear, 1933-34 Phaeton LH Rear	100.00	ea
40-711830	Latch striker, steel	25.00	ea
B-702268	Inside handle shaft tension spring (1935-36)	5.00	ea

**Latches, Dovetails & Bumpers cont**

**Rumble: 1932 3 Window, 1933-34 Coupe Roadster & Cabriolet**

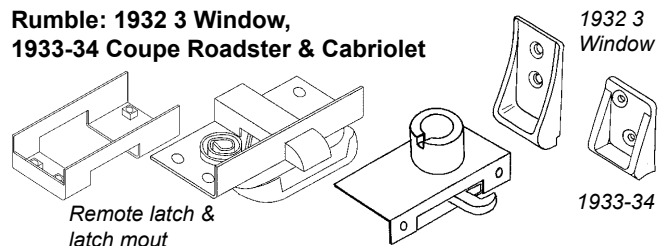

			1932 3 Window
			1933-34
	<i>Remote latch &amp; latch mout</i>		
B-527102	Latch, remote style, Coupe & Cabriolet	25.00	ea
B-527103	Remote style mounting bracket, to drip rail	12.50	ea
A-41604-B	Latch, outside handle style, roadster	50.00	ea
B-525780	Striker, 1932 3 Window	10.00	ea
40-765780	Striker, cast bronze, 1933-34	25.00	ea
40-52500	Striker, outside handle type, roadster	n.a	
B-41518	Upper (round) bumpers, 3/4" tall	5.00	pr
B-41518-T	Upper (round) bumpers, 7/8" tall	5.00	pr
B-41484	Lower stop (rectangular) bumpers	7.50	pr
40-714008-S	Lower stop bracket kit (w/bumpers)	15.00	set

**Trunk Lid: 1932 3 Window Coupe 1933-34 Coupe, Roadster & Cabriolet**

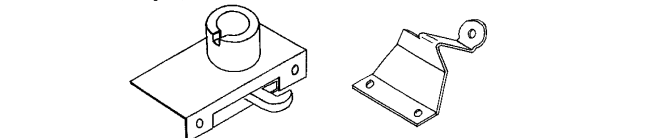

A-41604-B	Latch:	50.00	ea
B-41615-3W	Striker plate: 1932 3 Window	n.a	
40-41615	Striker plate: 1933-34	12.50	ea
B-41518	Lower (round) bumpers, 3/4" tall	5.00	pr
B-41518-T	Lower (round) bumpers, 7/8" tall	5	n.a

**Doors: 1935-36 Coupe, Sedan, Cabriolet**

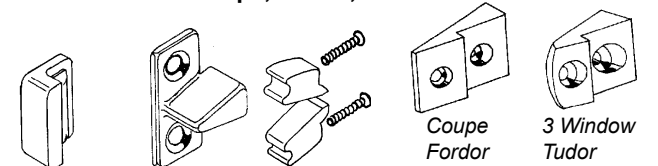

			Coupe Fordor	3 Window Tudor
B-46440	Door bumpers	1.75	ea	
48-702550-A	Dovetail, stainless: Passenger	12.50	ea	
40-702550-S	Dovetail mounting screws	1.00	set	
48-702574-RK	Dovetail socket repair kit	7.50	ea	
B-46137-A	Latch striker, plain: Coupe/Fordor	7.50	ea	
40-702340-SS	Latch striker, stnls: Coupe/Fordor	10.00	ea	
48-46137	Latch striker, plain: Tudor/Club Cpe	7.50	ea	
81A-702340-SS	Latch striker, stnls: Tudor/Club Cpe	10.00	ea	
48-702336-A	Latch striker nut plate: Coupe/Fordor, 35-37 PU	12.50	pr	
48-702410	Latch: RH, 1935-36 Coupe, Sedan, Cabriolet	n.a		
48-702411	Latch: LH, 1935-36 Coupe, Sedan, Cabriolet	n.a		
68-702267	Door latch repair: spring: 35-36 (7/8" dia)	7.50	ea	
78-702267	Door latch repair: spring: 36-37 (1-1/8" dia)	2.00	ea	
B-702269	Door latch repair: spring retainer clip	4.00	ea	
81A-732412/3-NA	Inside Handle Mount w/o link	55.00	pr	
B-702268	Inside handle shaft tension spring	5.00	ea	

**Latches, Dovetails & Bumpers cont**

**Doors: 1935-37 Pickup**

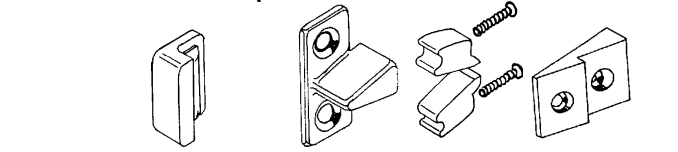

B-46440	Door bumpers	1.75	ea
40-702550-D	Dovetail, stainless: Pickup	7.50	ea
40-702550-S	Dovetail mounting screws	1.00	set
48-702574-RK	Dovetail socket repair kit	7.50	ea
B-46137-A	Latch striker, plain	7.50	ea
40-702340-SS	Latch striker, stnls	10.00	ea
48-702336-A	Latch striker nut plate	12.50	pr
50-811850	Latch: RH, 1935-37 Pickup	n.a	
50-811851	Latch: LH, 1935-37 Pickup	n.a	
81A-732412/3-NA	Inside Handle Mount w/o link	55.00	pr
68-702267	Door latch repair: spring: 35-36 (7/8" dia)	7.50	ea
78-702267	Door latch repair: spring: 36-37 (1-1/8" dia)	2.00	ea
B-702269	Door latch repair: spring retainer clip	4.00	ea
81A-732412/3-NA	Inside Handle Mount w/o link	55.00	pr
B-702268	Inside handle shaft tension spring	5.00	ea

**Rumble or Trunk: 1935-36 Coupe, Roadster, Cabriolet 1937 Roadster & Cabriolet (rumble)**

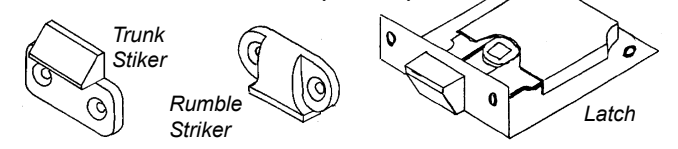

			Trunk Striker	Rumble Striker	Latch
48-52502	Latch	32.50	ea		
48-713780-B	Striker, trunk lid, cast bronze	25.00	ea		
48-713780-E	Striker, rumble lid, cast bronze	25.00	ea		
B-41484	Rumble lower stop (rectangular) bumpers	7.50	pr		
40-714008-S	Rumble lower stop bracket kit (w/bumpers)	15.00	set		
48-725854	Trunk lid lower drain hoses	7.50	pr		

**Doors: 1935-36 Convertible Sedan 1937-40 Convertible & Convertible Sedan**

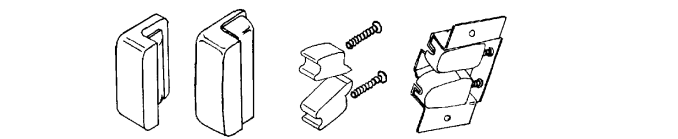

B-46440	Door bumpers: 1935-36	1.75	ea
78-46440	Door bumpers: 1937-40	1.50	ea
48-702550-A	Dovetail, stainless	12.50	ea
40-702550-S	Dovetail mounting screws	1.00	set
48-702574-RK	Dovetail socket repair kit (metal jaw type)	7.50	ea
78-702570-S	Dovetail socket assy, weld in, plastic jaw type	20.00	pr
01A-702610-S	1940: Striker plate bumpers & plugs (4 each)	10.00	set
78-711800	Latch: RH, 1937-39 Roadster, Phaeton, Convert	n.a	
78-711801	Latch: LH, 1937-39 Roadster, Phaeton, Convert	n.a	
01A-661800	Latch: RH, 1940 Convertible	n.a	
01A-661801	Latch: LH, 1940 Convertible	n.a	
91A-7622010	Latch striker: unpolished stainless	30.00	ea
91A-7622010-S	Latch striker: polished stainless	35.00	ea
B-702268	Inside handle shaft tension spring	5.00	ea

**Latches, Dovetails & Bumpers cont**

**Doors: 1937-40 Coupe, Sedan, Pickup  
1938-52 Pickup**

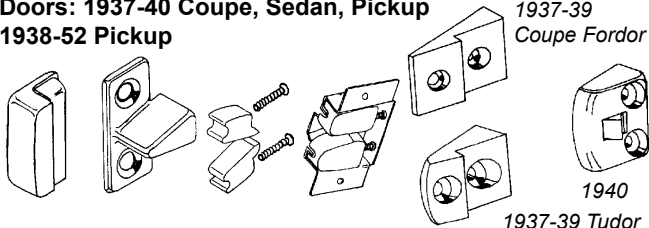

78-46440	Door bumpers: 1937-40	1.50 ea
48-702550-A	Dovetail, stainless: Passenger	12.50 ea
40-702550-D	Dovetail, stainless: Pickup 1935-41	7.50 ea
11A-702550-A	Dovetail, stainless: Pickup 1942-52	7.50 ea
40-702550-S	Dovetail mounting screws	1.00 set
48-702574-RK	Dovetail socket repair kit (metal jaw type)	7.50 ea
78-702570-S	Dovetail socket assy, weld in, plastic jaw type	20.00 pr
B-46137-A	Latch striker, plain: 37-39 Coupe/Fordor	7.50 ea
40-702340-SS	Latch striker, stnls: 37-39 Coupe/Fordor	10.00 ea
48-46137	Latch striker, plain: 37-39 Tudor/Club Cpe	7.50 ea
81A-702340-SS	Latch striker, stnls: 39-39 Tudor/Club Cpe	10.00 ea
01A-7022008	Latch striker, plain: 39/40 Merc, 40 Ford	17.50 ea
01A-7022008-C	Latch striker, chrome: 39/40 Merc, 40 Ford	10.00 ea
48-702336-A	Latch striker nut plate: Coupe/Fordor, 35-37 PU	12.50 pr
01A-7021812/3	Latches: RH & LH, 1937-40 Closed	175.00 pr
81A-732412/3	Inside Handle Mount w/link: 1937-40 Cp/4D	60.00 ea
81A-732412/3-NA	Inside Handle Mount w/o link	55.00 pr
81A-702267	Door latch repair: spring: 38-40 small	7.50 ea
81A-702267-A	Door latch repair: spring: 38-40 large	7.50 ea
B-702269	Door latch repair: spring retainer clip	4.00 ea
B-702268	Inside handle shaft tension spring	5.00 ea

**Trunk Lid: 1937-38 Coupe & Cabriolet, 1937-39 Sedan**

78-52502	Latch: 1937	32.50 ea
81A-52502	Latch: 1938	32.50 ea
78-52500-A	Striker, stainless: 1937-38 Coupe	40.00 ea
78-52500-B	Striker, stainless: 1937-39 Sedan	40.00 ea

**Rumble: (remote type latch): 1938-39 Convertible**

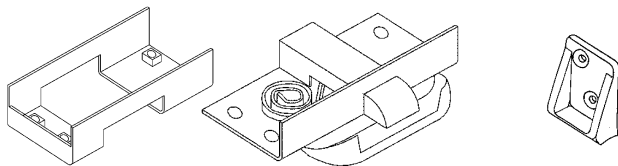

B-527102	Latch	25.00 ea
91A-7643222	1939 Convertible rumble latch pad	25.00 ea
B-527103	Mounting bracket, welds to drip rail	12.50 ea
40-765780	Striker, cast bronze,	25.00 ea
B-41484	Lower stop (rectangular) bumpers	7.50 pr
40-714008-S	Lower stop bracket kit (w/bumpers)	15.00 set

**Trunk Lid: 1939-40 Coupe**

01A-52502-A	Latch	32.50 ea
01A-52500-A	Striker, stainless	50.00 ea

**Trunk Lid: 1940 Sedan**

01A-52502-B	Latch	32.50 ea
01A-52500-B	Striker, stainless	35.00 ea

**Latches, Dovetails & Bumpers cont**

**Doors: 1941-48 Coupe, Sedan, Convertible**

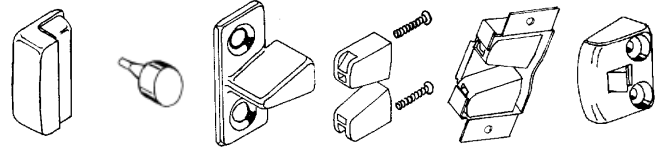

78-46440	Door lower bumpers	1.50 ea
11A-7023020-B	Door upper rear corner bumpers	3.00 pr
11A-702550-A	Dovetail, stainless	7.50 ea
40-702550-S	Dovetail mounting screws	1.00 set
11A-702574-RK	Dovetail socket repair kit	7.50 ea
11A-702570-S	Dovetail socket assy, weld in	20.00 pr
11A-7022008	Latch striker, plain	17.50 ea
11A-7022008-C	Latch striker, chrome	10.00 ea
11A-702267	Door latch repair: spring, large	7.50 ea
11A-702267-A	Door latch repair: spring, small	7.50 ea
B-702269	Door latch repair: spring retainer clip	4.00 ea
11A-702268	Inside handle shaft tension spring	4.00 ea

**Trunk Lid: 41-48**

21A-52502-A	Latch (rotater type): 1941-48 Coupe*	32.50 ea
11A-52502-B	Latch (plunger type): 1941-48 Sedan*	32.50 ea
11A-52500	Striker: 1941-48 Coupe*	50.00 ea
11A-52500-B	Striker: 1941-48 Sedan*	40.00 ea

\*some early 1941 coupes used plunger type latch

**1953-56 F-100**

BAAA-702350-R	Latch stiker: RH, 1953-55	20.00 ea
BAAA-702350-L	Latch stiker: LH, 1953-55	20.00 ea
B6C-702350-R	Latch stiker: RH, 1956	20.00 ea
B6C-702350-L	Latch stiker: LH, 1956	20.00 ea
BA-702340-SK	Door striker screw set (3 pc), 53-56 PU	2.00 set
BAAA-8121818-RK	Inside Door Handle Shaft Repair Kit	15.00 ea

